



POSTURITE[®]
Because Health Matters
2011/2012



Celebrating 20 years of unrivalled service

For 20 years Posturite has been helping British companies, government departments and local authorities to protect their employees against back problems and work-related upper limb disorders (WRULD).

A combination of world-leading, innovative products and matchless customer service has helped us to become the UK's leading provider of ergonomic solutions for the workplace with a hugely dominant share of the curative sales market.

We have service level agreements in place with well over 500 major private and public sector organisations to help them protect their workers and swiftly resolve health issues relating to their working environment. Over the years, we have helped thousands of people to overcome musculoskeletal conditions that were not only causing them pain but also preventing them from working effectively, if at all.

I am immensely proud of what we have achieved. From a single product in 1991 – a writing slope that I had originally designed and produced in my mother's garage to help overcome a recurring neck pain problem that had caused me to quit my desk job in the City – we have grown to become the pre-eminent UK-wide provider of ergonomic furniture and accessories, and the only company able to offer organisations a single source solution for all of their health, safety and First Aid equipment and training needs.

Superb products – like our recently-introduced Penguin ambidextrous vertical mouse – and excellent customer service have been fundamental to our growth.

A 50-strong team of locally-based account managers and client support executives – many of them graduates in human biomechanics and all of them qualified DSE assessors – look after work station assessments, provide advice and training on ergonomic products, and ensure that chairs, desks and other items of equipment are properly adjusted for the individual's personal comfort once delivered.

It's a unique offering that has helped to reduce absenteeism, increase productivity and improve staff retention in scores of UK businesses. And it's why, in these difficult economic times, more organisations than ever are turning to Posturite to deliver the sort of quantifiable performance and return on investment improvements that are essential when budgets are under ever-increasing scrutiny.

Hopefully you'll find all you need to meet your requirements in this catalogue. But don't hesitate to give us a call and speak to one of our experienced customer service advisers if you're at all unsure about the products and services that will best suit your needs.

And please make sure that you pay regular visits to our website – www.posturite.co.uk – to avoid missing out on any of the regular special offers that we'll be running throughout our 20th anniversary year.

We look forward to working with you over the coming months.

Ian Fletcher-Price
CEO



WorkRite provides custom-designed e-learning and assessment software, consultancy and training services to help companies implement and conduct effective health and safety regimes in accordance with current legislation. Organisations can create their own bespoke programmes from a menu of health and safety management and training solutions.

tel: +44 (0) 845 345 0030

web: www.workrite.co.uk

Office Environments

Office Environments offers a range of creative, cost-effective, full interior office refurbishment solutions. Whether you're fitting out a single office or an entire building, our comprehensive planning, design and supply-and-fit service will ensure you make optimum use of your office space...and your budget!

tel: +44 (0) 845 4080 640

web: www.office-environments.co.uk



MediRite provides all the products and services companies need to meet their essential First Aid supplies and training requirements, in addition to a comprehensive range of Occupational Health, safety and medical products such as defibrillators, evacuation chairs and audiometers.

tel: +44 (0) 845 199 9991

web: www.medirite.co.uk

Assistive Technology

In partnership with: **iansyst**

iansyst Ltd is a leading assistive technology company that helps people with disabilities to reach their full potential. Posturite customers are able to take advantage of iansyst's experience in providing product, training and consultancy solutions and services to people with conditions such as dyslexia, dyspraxia, and dyscalculia, and visual and hearing impairments.

tel: +44 (0) 845 345 0010

web: www.posturite.co.uk



An invitation



Have you visited our head office yet? If not, we would like to invite you to come to see us at our historic converted mill which also houses a showroom where you can try our products and learn about our services first hand. The Mill is ideally located at the foot of the beautiful South Downs next to Berwick Railway Station, just 70 minutes from London Victoria. To arrange a visit, either contact your local Account Manager or call Rob Petrides, our Head Office Account Manager, on 0845 345 0010.

Contents

2011/2012

05 Ergonomic Seating

Office • Heavy Duty • Industrial • Stools • Visitor/Conference

23 Desking & Furniture

Desks • Pedestals • Storage • Accessories

29 Input Devices

Keyboards • Mice • Tablets

41 Workstation Accessories

Document Holders • Writing Boards • Writing Slopes • Headsets

47 Monitor Solutions

Monitor Arms • Monitor Raisers • Screen Filters • CPU Holders

53 Laptop Solutions

Laptop Sets • Laptop Stands • Bags • iPad & Tablet Solutions

59 Supports

Footrests • Wrist Rests

63 Self-Help & Posters

Posters • Lumbar Rolls & Wedges • Body Supports

67 WorkRite

E-learning • Training • Consultancy

71 Office Environments

Office Re-Fit • Refurbishments • Design & Build

75 MediRite

First Aid Supplies • Defibrillators • Evacuation Chairs

79 Assistive Technology

Training • Hardware • Software

Seating Selection Form

Please fill in the form below and send to us:

fax: 0845 345 0010

email: support@posturite.co.uk

web: www.posturite.co.uk/seatingselection

PERSONAL INFORMATION

Name :	
Company :	
Workplace address :	
Contact telephone number :	
Contact email address :	
Please describe any musculoskeletal disorders, previous spinal injuries and any back pain experienced while seated :	
Please outline what makes any pain/discomfort experienced better or worse :	

MEASUREMENTS

Height (cm) :	
Weight (kg) or (stone) :	
A - Back of knee joint to floor (with shoes) :	
B - Back of buttock to back of knee :	
C - Seat surface to shoulder :	
D - Seat surface to middle of lumbar curve :	
E - Hip width (at widest point) :	
F - Seat surface to nape of neck :	
G - Floor to desk height (if desk not height adjustable) :	

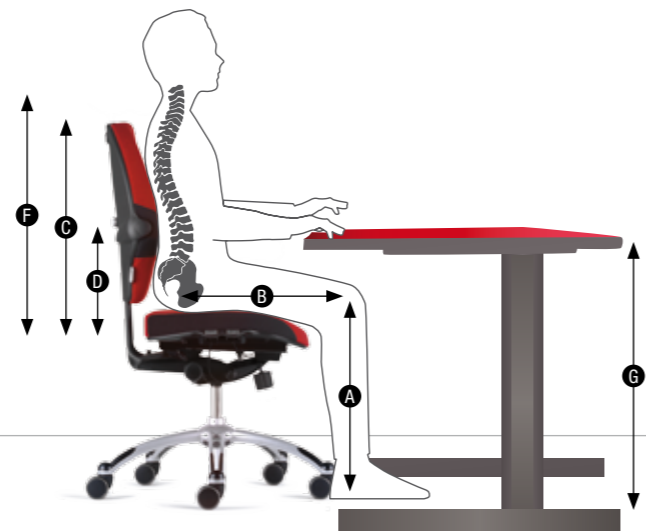

CHAIR REQUIREMENTS / PREFERENCES

Chair arms (yes/no) :	
Neckrest / headrest (yes/no) :	
Fabric preference :	
Fabric colour preference :	
Floor type (wood, carpet etc) :	
Additional requirements :	

Ergonomic Seating

Office • Heavy Duty • Industrial • Stools • Visitor/Conference

Musculoskeletal disorders (MSDs) are the scourge of the modern office. The Work Foundation calculates that they cost the European economy a staggering 240 billion Euros per year. In the UK alone, the figure is an eye-watering £7 billion.

Yet many cases of MSDs could be avoided if only companies invested proactively in multi-adjustable ergonomic office chairs, properly set up to meet the needs of individual users.

This is what HSE Board member Professor Sayeed Khan has to say on the subject.

“Ergonomic solutions to workplace design can help prevent back injuries, stop existing conditions being exacerbated and help sufferers feel more comfortable. They can also improve conditions for everyone.”

All our office chairs are designed to maintain the health and efficiency of desk-based workers. We have partnered with many of the world's leading designers and manufacturers to ensure our customers have the biggest and best choice of posture-improving office chairs to suit all budgets.

If you're unsure which chair would best meet your needs, why not take advantage of your local Posturite Account Manager's expertise to help you choose. They'll also make sure the chair is properly adjusted for the user's personal comfort once it's delivered.

Meanwhile, check out our website where you'll find all sorts of tips about the art of sitting.

www.posturite.co.uk

The Knowledge

All the info you need to help you choose your chair

Check our weblink to
The Art of Sitting
<http://www.posturite.co.uk/artofsitting>



Model	RH Logic 300/400	Extend	RH Activ	RH Logic 3/4	Ambio	HÅG H03	HÅG H04	HÅG H05	HÅG Futu	Positiv Plus	Positiv Range
Price	From £737.00	From £539.00	From £419.00	From £732.00	From £798.00	From £290.00	From £408.00	From £430.00	From £438.00	From £524.00	From £195.00
Back Type	Medium, Large	Medium, Large	Small, Medium	Medium, Large	Medium, Large	Small, Medium	Small, Medium, High	Small, Medium, High	High	Medium, Large, Slim	Medium, Large
Seat Height Adjustment	✓	✓	✓	✓	✓	✓	✓	✓	✓	✓	✓
Back Height Adjustment	✓	✓	✓	✓	✓	✓	✓	✓	✓	✓	✓
Type of Movement	Knee Tilt	Knee Tilt	Central Tilt	Knee Tilt	Knee Tilt	Central Tilt	Central Tilt	Central Tilt	Central Tilt	Knee Tilt	Central Tilt
Back Angle Adjustment	Infinite	Infinite (selected models)	Infinite	Infinite	Infinite	N/A	N/A	N/A	N/A	Infinite	Infinite (selected models)
Free Float	✓	✓	✓	✓	✓	✓	✓	✓	✓	✓	✓
Seat Slide	✓	✓	✓	✓	✓	✓	✓	✓	✓	✓	Optional
Adjustable Lumbar	✓	✗	✗	✓	✗	✗	✗	✗	✓	✓	Optional
Adjustable Armrest	✓	✓	✓	✓	✓	✓	✓	✓	✓	✓	Optional
Neck Rest	✓	✓	✗	✓	✓	✗	✓	✓	✗	✓	U600 Only
Maximum Weight (kg)	150	150	150	150	150	150	150	150	110	150	150
Guarantee (Years)*	10	10	10	5	10	10	10	10	10	5	5
Finger Tip Controls	✓	✓	✗	✓	✓	✗	✗	✗	✗	✗	✗

*Average daily use



Model	HÅG Capisco	HÅG H09	Grahl DUO-BACK Type 11	KAB 24hr Controller	BE-GE 24hr 852	Body Bilt 2500/3500	Score Maxx
Price	From £232.00	From £595.00	From £539.00	From £710.00	From £999.00	From £1,099	From £1,247.00
Back Type	Alternative	Medium, High	Split	High	High	High	Medium
Seat Height Adjustment	✓	✓	✓	✓	✓	✓	✓
Back Height Adjustment	✓	✓	✓	✓	✓	✓	✓
Type of Movement	Central Tilt	Central Tilt	Central Tilt	Central Tilt	Central Tilt	Central Tilt	N/A
Back Angle Adjustment	Infinite	N/A	Infinite	Infinite	Infinite	Infinite	Infinite
Free Float	✓	✓	N/A	✓	✓	✓	✗
Seat Slide	✓	✓	✓	✓	✓	✓	✗
Adjustable Lumbar	✗	✓	N/A	✓	✓	✓	✗
Adjustable Armrest	✗	✓	✓	✓	✓	✓	✓
Neck Rest	✓	✓	✓	✓	✓	✓	✗
Max Max Weight (kg)	110	150	114	150	150	227	250
Guarantee (Years)*	10	10	5	2	3	1	5
Finger Tip Controls	✗	✗	✗	✗	✗	✗	✗

*Average daily use

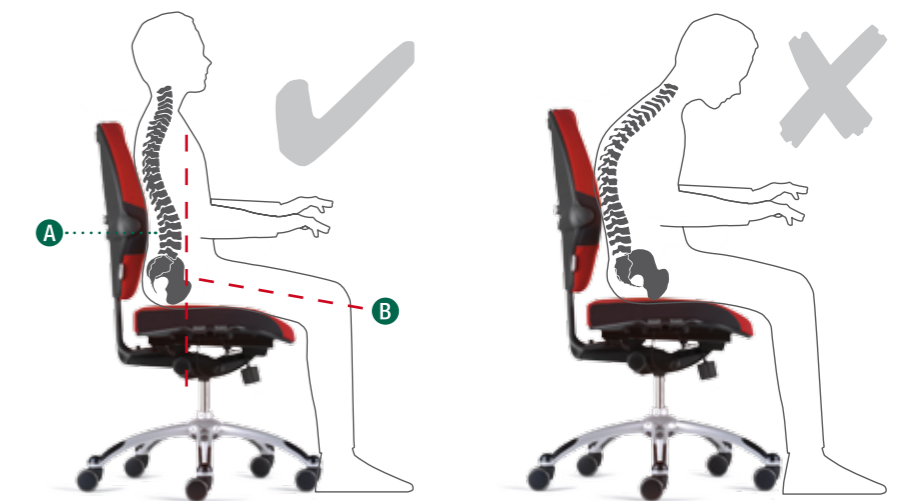

Correct working posture

Always sit back and move your chair close to the desk to maintain contact between your back and the seat back. It is important to support and maintain the inward curve (A) of the lumbar spine. Ideally choose a seat which has a forward tilt of 5-15° which will encourage a position that allows your hips to be slightly higher than your knees (B).

Poor working posture

Often caused by perching on the edge of your seat or by stretching to reach your mouse / keyboard if positioned too far away. This will encourage incorrect slouching where the pelvis rotates backwards resulting in the loss of the inward curve of the lumbar spine and causing increased strain on the lumbar discs and other structures.

RH Logic 400/300

One of our most popular chairs, comfortably suiting a wide variety of people and work situations.

The RH Logic 400 has a high back, the RH Logic 300 has a lower back. The RH Logic 400/300 suits different people and work situations with a wide range of different fabrics and options, such as extra large seat, coccyx cutout and control room design. Also available in an ESD-approved version.

RH Logic 300 - Medium Back

RH Logic 300 comes as standard with lumbar pump, castors for carpeted floors, base in graphite aluminium and 8S Class A adjustable armrests.

Measurements:

- **Backrest (WxH):** 440 x 510 mm
- **Seat (WxD):** 465 x 475 mm (sliding range 60 mm)
- **Seat height:** 410-530 mm

RH Logic 400 - High Back

RH Logic 400 comes as standard with lumbar pump, castors for carpeted floors, base in graphite aluminium and 8S Class A adjustable armrests.

Measurements:

- **Backrest (WxH):** 440 x 620 mm
- **Seat (WxD):** 465 x 475 mm (sliding range 60 mm)
- **Seat height:** 410-530 mm

RH Logic 400 Elegance

As standard, the RH Logic 400 Elegance is equipped with an adjustable air-filled lumbar support, upholstered backshell, castors for carpeted floors, base in graphite aluminium and 8S Class A adjustable armrests.

RH Logic 400 24-hour Control Room Chair

RH Logic 400 24-hour has an extra wool layer in the seat and back to enhance ventilation and comfort. Otherwise the control room chair has the same features as the standard chair. 24/7 fabric or leather only.

Options / Accessories

Customise to suit your needs, work tasks and aesthetic preferences. Speak to one of our experts who can walk you through the options.

- Neckrest
- Armrests
- Coccyx cutout
- XL seat (WxD): 485 x 515 mm (high gas stem as standard)
- Memory foam seat (adds 30 mm thickness)
- Base (choice of black or silver)
- Castors (carpeted or hard floor)
- Coat hanger
- Gas stems

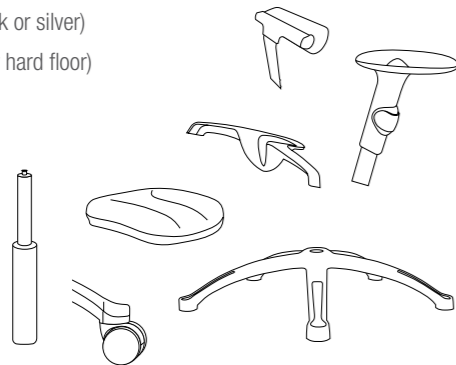

RH Logic 300

RH Logic 400



RH Logic 400 Elegance

RH Logic 400 24-hour

0380203	RH Logic 400 No Neckrest Grp3	£794.00
0380103	RH Logic 400 Complete Grp3	£842.00
0390203	RH Logic 300 No Neck Grp3	£737.00
0390103	RH Logic 300 Comp Grp3	£785.00
0381704	RH Logic 400 24hr Comp Chair 24/7 Fabric	£889.00
0382103	RH Logic 400 Elegance Comp Grp3	£919.00
036712	RH Coccyx Cut Out for Logic 3/4/400/300	£47.00
0361920U	Upgrade to a Logic XL Performance Seat	£45.00

Colour Options (please select when ordering)

Stock Colours - Gaja

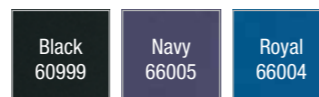

Please call us for a full range of swatches & fabrics available. POA.

RH Extend

A range of very functional office chairs at attractive prices. Flexible and elegant office chairs.

Elegant, ergonomic and easy to use. The chair is equipped with a lever that makes it easy to choose exactly the right sitting position, something that makes it the perfect choice for an environment where hot-desking is the norm and many different people use it at different times. RH Extend is ideally suited to all types of office environments and the backrest is available in two different sizes.

RH Extend comes as standard with castors for soft floors, base in graphite aluminium and 8S Class A adjustable armrests.

RH Extend 100 - Medium Back

The RH Extend 100 offers a backrest and seat angle that move simultaneously when you change your position. The chair maintains its basic settings regardless of whether you lean forwards or backwards or whether you lock or release the tilt mechanism.

Medium Back Measurements:

- **Backrest Medium (WxH):** 440 x 510 mm
- **Seat (WxD):** 460 x 470 mm (sliding range 60 mm)
- **Seat height:** 400-510 mm

RH Extend 120 - High Back

The RH Extend 120 offers the same functions as RH Extend 100 although with a taller backrest.

Large Back Measurements:

- **Backrest (WxH):** 440 x 620 mm
- **Seat (WxD):** 460 x 470 mm (sliding range 60 mm)
- **Seat height:** 400-510 mm

RH Extend 200 - Medium Back

RH Extend 200 has a tilt mechanism and backrest that can be adjusted separately. The back plate can be angled precisely according to individual preference, making this a uniquely adjustable and user-friendly chair. RH Extend comes as standard with castors for soft floors, base in graphite aluminium and 8S Class A adjustable armrests.

RH Extend 220 - Large Back

The RH Extend 220 offers the same functions as RH Extend 200 but with a taller backrest.

Options / Accessories

Customise to suit your needs, work tasks and aesthetic preferences. Speak to one of our experts who can walk you through the options.

- Neckrest
- Armrests
- Base (choice of black or silver)
- Castors (carpeted or hard floor)
- Coat hanger
- Gas stems

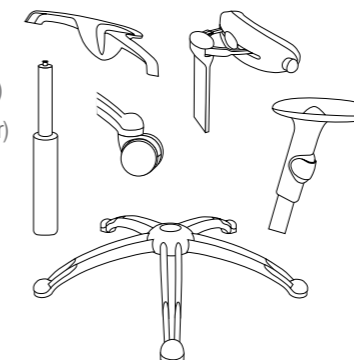

RH Extend 100

RH Extend 120



RH Extend 200

RH Extend 220

0333103	RH Extend Medium Grp3	£539.00
0334103	RH Extend Large Grp3	£588.00
0343103	RH Extend Medium Independent Grp3	£631.00
0344103	RH Extend Large Independent Grp3	£681.00
0361940	RH Extend Neckrest New Style	£80.00
0361915	RH Logic 400/300/Extend Coat Hanger	£28.00
0361703U	Upgrade RH Castor 7H for hard floors	FOC

Colour Options (please select when ordering)

Stock Colours - Gaja

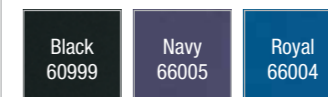

Please call us for a full range of swatches & fabrics available. POA.

RH Activ

Chairs for office and industry.

RH Activ follows your slightest body movement - comfortably as well as ergonomically. Just like every one of RH's chairs, it is based on 2PPT™, the philosophy on active sitting. RH Activ is a chair that thanks to its simplicity and ergonomic design fits most working environments. This chair range comes in four basic models which can be fitted with a higher gas stem, footring and glides to create a Draughtsman chair.

RH Activ 200

RH Activ 200 has a medium backrest and medium seat. Base in black polyamide and castors for carpeted floors. Armrests as standard.

Measurements:

- **Backrest medium (WxH):** 370 x 295 mm
- **Seat medium (WxD):** 440 x 430 mm
- **Seat height:** 397-527 mm

RH Activ 220

RH Activ 220 has a large backrest and medium seat. Base in black polyamide and castors for carpeted floors. Armrests as standard.

Measurements:

- **Backrest large (WxH):** 370 x 430 mm
- **Seat medium (WxD):** 440 x 430 mm
- **Seat height:** 397-527 mm

RH Activ 202

RH Activ 202 has a medium backrest and large seat. Base in black polyamide and castors for carpeted floors. Armrests as standard.

Measurements:

- **Backrest medium (WxH):** 370 x 295 mm
- **Seat large (WxD):** 460 x 460 mm
- **Seat height:** 397-527 mm

RH Activ 222

RH Activ 222 has a large backrest and large seat. Base in black polyamide and castors for carpeted floors. Armrests as standard.

Measurements:

- **Backrest large (WxH):** 370 x 430 mm
- **Seat large (WxD):** 460 x 460 mm
- **Seat height:** 397-527 mm

Options / Accessories

Customise to suit your needs, work tasks and aesthetic preferences. Speak to one of our experts who can walk you through the options.

- Armrests
- Base
- Footrest
- Gas stem
- Castors
- Flexible arm support
- Sliding seat

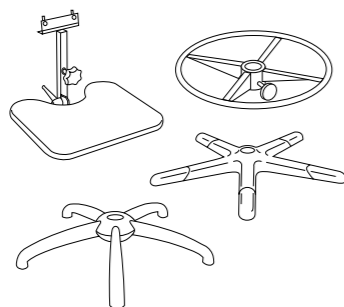

10 Year
Guarantee
8hr use



Activ 200

Activ 220



Activ 202

Activ 222

0344503	RH Activ 200 Grp3	£419.00
0345503	RH Activ 200 Draughtsman Grp 3	£482.00
0344703	RH Activ 220 Grp3	£444.00
0345703	RH Activ 220 Draughtsman Grp 3	£516.00
0344603	RH Activ 202 Grp3	£438.00
0345603	RH Activ 202 Draughtsman Grp 3	£501.00
0344803	RH Activ 222 Grp3	£463.00
0345803	RH Activ 222 Draughtsman Grp 3	£535.00

Colour Options (please select when ordering)

Stock Colours - Gaja

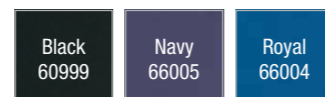

Please call us for a full range of swatches & fabrics available. POA.

RH Logic 3 & 4

A reliable classic in a range of designs.

RH Logic is a durable and highly adjustable range of chairs suitable for a wide range of working environments and users. RH Logic is entirely designed on the basis of 2PPT™, RH Chairs philosophy on the importance of flexibility in sitting, to keep you going during long working days. The backrest can be adjusted separately, while all basic settings are maintained, even when using the tilt mechanism.

RH Logic 3 - Medium Back

RH Logic 3 has a shaped back with pronounced support for the curve of the back and extra padding to provide support between the shoulders. The backrest narrows towards the top to allow greater freedom of movement. The chair comes standard with a sliding seat, a lumbar pump, a base in grey-lacquered aluminium and castors for carpeted floors.

Measurements:

- **Backrest (WxH):** 440 x 450 mm
- **Seat (WxD):** 480 x 460 mm (sliding range 60 mm)
- **Seat height:** 410-530 mm

RH Logic 4 - High Back

RH Logic 4 has as a high backrest with extra padding to provide support between the shoulders and pronounced support for the curve of the back to provide optimum sitting comfort and strain relief. The backrest narrows towards the top to allow greater freedom of movement for the arms. The chair comes standard with an adjustable neckrest, a lumbar pump, sliding seat, base in grey-lacquered aluminium and castors for carpeted floors.

Measurements:

- **Backrest (WxH):** 450 x 630 mm
- **Seat (WxD):** 470 x 480 mm (sliding range 50 mm)
- **Seat height:** 435-550 mm

RH Logic 4 Exclusive

RH Logic 4 Exclusive has a seat and backrest with extra deep padding and has quality stitched seams. The chair comes standard with an adjustable neckrest, a lumbar pump, sliding seat, base in grey-lacquered aluminium and castors for carpeted floors.

RH Logic 4 Elegance

RH Logic 4 Elegance has an upholstered seat and backrest with extra deep padding and has quality stitched seams. The chair comes standard with an adjustable neckrest, a lumbar pump, sliding seat, a base in grey-lacquered aluminium and castors for carpeted floors.

Options / Accessories

Customise to suit your needs, work tasks and aesthetic preferences. Speak to one of our experts who can walk you through the options.

- Neckrest
- Armrests
- Coccyx Cutout
- Memory Foam Seat (adds 30mm thickness)
- Base (choice of black or silver)
- Castors (soft or hard floor)
- Gas stems

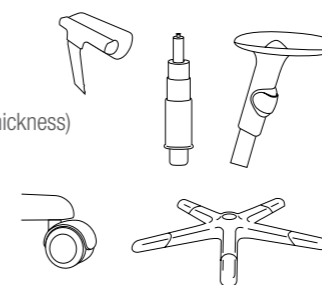

5 Year
Guarantee



RH Logic 3

RH Logic 4



RH Logic 4 Exclusive

RH Logic 4 Elegance

0303103	RH Logic 3 Grp 3	£732.00
0304103	RH Logic 4 Complete Grp 3	£890.00
0304203	RH Logic 4 No Neckrest Grp 3	£845.00
0305103	RH Logic 4 Exclusive Complete Grp 3	£1,051.00
0305403	RH Logic 4 Elegance Grp 3	£1,218.00
036712	RH Coccyx Cut Out for Logic 3/4/400/300	£47.00
0361710	RH 30mm Extra Seat Padding (Soft) RH3/4	£78.00
0361711	RH 30mm Memory Foam Seat Padding	£105.00

Colour Options (please select when ordering)

Stock Colours - Gaja

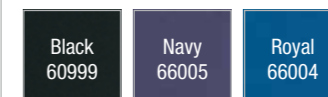

Please call us for a full range of swatches & fabrics available. POA.

RH Ambio

Ergonomic office chairs that breathe.

RH Ambio is a new range of ergonomic office chairs constructed for the modern office environment. Thanks to Zenit Design Group, who designed the chairs, they look as great as they feel to sit in. In addition, the RH Ambio is upholstered with Ventec™, a unique RH-developed product with an outstanding capacity to transport moisture and heat, which keeps you and your chair fresh.

RH Ambio 200 - Medium Back

RH Ambio 200 has a tilt mechanism and backrest that can be adjusted separately. This office chair follows your movements while maintaining its basic settings, regardless of whether you lean forward or backward, or if you sit with the tilt mechanism open or locked. The backrest can be angled to suit you— providing support and relief for your whole back. You can even adjust the backrest angle and increase the angle between the backrest and the seat. This is an ergonomic office chair with optimised functions.

Measurements:

- **Backrest (WxH):** 440 x 480 mm
- **Seat (WxD):** 465 x 430 mm
- **Seat height:** 435-555 mm

RH Ambio 202 - Medium Back (Large Seat)

The RH Ambio 202 is the same chair as the RH Ambio 200, but with a large seat.

Measurements:

- **Seat (WxD):** 465 x 485 mm

RH Ambio 220 - High Back

The RH Ambio 220 is the same chair as the RH Ambio 200, but with a high back.

Measurements:

- **Backrest (WxH):** 440 x 600 mm
- **Seat (WxD):** 465 x 430 mm
- **Seat height:** 430-555 mm

RH Ambio 222 - High Back (Large Seat)

The RH Ambio 222 is the same chair as the RH Ambio 220, but with a large seat.

Measurements:

- **Seat (WxD):** 465 x 485 mm

Options / Accessories

Customise to suit your needs, work tasks and aesthetic preferences. Speak to one of our experts who can walk you through the options.

- Neckrest
- Armrests
- Gas stem
- Coat Hanger
- Lockable storage box
- Detachable soft case



10 Year
Guarantee
8hr use



RH Ambio 200

RH Ambio 220



RH Ambio 202

RH Ambio 222

0346000	RH Ambio 200 Black Edition Move	£798.00
0346100	RH Ambio 202 Black Edition Move	£842.00
0346200	RH Ambio 220 Black Edition Move	£850.00
0346300	RH Ambio 222 Black Edition Move	£894.00
0346001	RH Ambio Black Edition Neckrest	£88.00
0346002	RH Ambio Black Edition Coat Hanger	£30.00
0346003	RH Ambio Black Edition Lockable Box	£42.00
0346004	RH Ambio Black Edition Detachable Case	£30.00

Colour Options (please select when ordering)

Ambio Black Edition

Non-stock (please allow 4-6 weeks)



HÅG Capisco

'The Saddle Chair' – was designed and modelled on the horse rider's dynamic seating position.

If you're into innovation, HÅG Capisco is the office chair for you. You won't find another office chair so well suited to work surfaces at different heights or to height-adjustable desks. In a HÅG Capisco, you can sit equally comfortably facing forward or turned to the side, allowing you a broad reach. The chair has received a number of awards for its unique qualities and characteristic design. It has also been a forerunner in terms of environmentally friendly design and still has a very strong environmental profile compared to its competitors. You can choose a HÅG Capisco in good conscience.

The saddle seat can be adjusted between low and high working positions, all the way up to standing, enabling you to be more dynamic in your movements while still balanced. The seat height, seat depth and back height can be adjusted. Tilt resistance is adjustable and lockable.

HÅG Capisco 8107

HÅG Capisco 8107 is delivered with a seat, back and headrest. The saddle seat can be adjusted between low and high working positions, all the way up to standing, enabling you to be more dynamic in your movements while still balanced. The seat height, seat depth and back height can be adjusted. Tilt resistance is adjustable and lockable. The footbase is delivered in black or silver-lacquered aluminium. Standard 200 mm gas lift. A footbase in polished aluminium is optional.

Measurements:

- **Backrest (WxH):** 580 x 480 mm
- **Seat (WxD):** 490 x 370-460 mm
- **Seat height:** 485-660 mm

HÅG Capisco 8106

The HÅG Capisco 8106 is the same chair as the HÅG Capisco 8107 but without headrest. Delivered with a seat and back.

HÅG Capisco 8105 - Stool Only

The HÅG Capisco 8105 is the same chair as the HÅG Capisco 8106 but with a taller gas stem and without a backrest.

HÅG Capisco Puls 8010

HÅG Capisco 8010 is a plastic chair that is delivered with a seat and back. The seat has an integrated cushion for improved comfort. The footbase is delivered in black or silver-lacquered aluminium. Standard 200 mm gas lift. A footbase in polished aluminium, black plastic or blue-grey plastic is optional.

Options / Accessories

Customise to suit your needs, work tasks and aesthetic preferences. Speak to one of our experts who can walk you through the options.

- Headrest
- StepUp footrest
- Square seat option
- Other gas stem options
- Base (choice of black or silver)



HÅG

10 Year
Guarantee

24/7
5 Year
Guarantee



HÅG Capisco 8107

HÅG Capisco 8106



HÅG Capisco 8105

HÅG Capisco Puls 8010

0502201	HAG Capisco 8107 Grp 1	£694.00
0502101	HAG Capisco 8106 Grp 1	£587.00
0502501	HAG Capisco 8105 Grp 1	£232.00
0508101	HAG Capisco Puls 8010 Grp 1	£412.00
0510102	HAG StepUp	£80.00

Colour Options (please select when ordering)

Stock

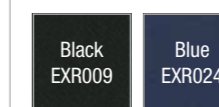

Please call us for a full range of swatches & fabrics available. POA.



Capisco Puls
plastic colour options:



HÅG H03 Collection

If you are looking for a flexible chair that adjusts easily to different needs, this is the perfect solution for you. HÅG H03 can easily be adjusted for different users regardless of their height and weight. Thanks to its unique rocking mechanism, you are always in balance and ready for your next move.

Chair Model	H03 330	H03 340	H03 350
Backrest Height	300-380 mm	410-590 mm	430-510 mm
Seat Width	510 mm	510 mm	465 mm
Seat Depth	390-490 mm	390-490 mm	390-490 mm
Seat Height	390-530 mm	390-530 mm	390-530 mm

HÅG H03 330 - Small Back

HÅG H03 330 is a narrow model with partially upholstered seat and low back, 150 mm gas lift, plastic footbase and castors for carpeted floors.

HÅG H03 340 - Medium Back

HÅG H03 340 has a partially upholstered seat and a medium height back, 150 mm gas lift, plastic footbase and castors for carpeted floors. A knob on the right-hand side of the chair adjusts the tilt resistance.

HÅG H03 350 - Medium Back - Upholstered

HÅG H03 350 has a fully upholstered seat and a medium height back, 150 mm gas lift, plastic footbase and castors for carpeted floors. A knob on the right-hand side of the chair adjusts the tilt resistance.

Options / Accessories

- Adjustable armrests
- Black or silver footbase
- Castors for hard or carpeted floors
- Higher gas stem

0506301	HAG H03 330 No Armrests Grp 1	£290.00
0506401	HAG H03 340 No Armrests Grp 1	£314.00
0506501	HAG H03 350 No Armrests Grp 1	£370.00
0506100	HAG H03 Adjustable Armrests	£47.00
0512100	Upgrade to H03 Aluminium Footbase	£24.00

Colour Options (please select when ordering)

Stock

Black
EXR009

Blue
EXR024

10 Year
Guarantee
9hr use

24/7
5 Year
Guarantee



HÅG H04 Collection

Key words describing HÅG H04 are balance, freedom and movement. Balance because it provides the best starting point for any movement, freedom of movement because it permits unrestricted movement, allowing you to focus on your work.

Chair Model	H04 4200	H04 4400	H04 4600
Backrest Height	470-560 mm	510-560 mm	590-680 mm
Seat Width	470 mm	470 mm	470 mm
Seat Depth	390-505 mm	390-505 mm	390-505 mm
Seat Height	390-530 mm	390-530 mm	390-530 mm

HÅG H04 4200 - Small Back

HÅG H04 4200 has a low back, standard 150 mm gas lift, silver footbase and castors for carpeted floors.

HÅG H04 4400 - Medium Back

HÅG H04 4400 has a medium height back, standard 150 mm gas lift, silver footbase, castors for carpeted floors and height and breadth-adjustable armrests.

HÅG H04 4600 - High Back

HÅG H04 4600 has a high back, standard 150 mm gas lift, silver footbase, castors for carpeted floors and height and breadth-adjustable armrests.

Options / Accessories

- Adjustable armrests
- Headrest
- Black or silver footbase
- Castors for hard or carpeted floors
- Higher gas stem
- StepUp footrest

0505201	HAG H04 4200 No Armrests Grp 1	£408.00
0505301	HAG H04 4400 Adj Armrests Grp 1	£559.00
0505401	HAG H04 4600 Adj Armrests Grp 1	£587.00
0505400	HAG H04 Adj Armrests Only	£59.00
0512701	HAG H04 Headrest Grp 1	£121.00
0510101	HAG StepUp	£80.00

Colour Options (please select when ordering)

Stock

Black
EXR009

Blue
EXR024

10 Year
Guarantee
9hr use

24/7
5 Year
Guarantee



HÅG H05 Collection

The HÅG H05 office chair is not only the perfect seating solution for achieving movement and variation – it is also brilliantly simple, all you need is a lever and a handle to make the necessary adjustments. The SwingBack function allows the armrests to easily be folded out of the way.

Chair Model	H05 5200	H05 5300	H05 5600
Backrest Height	450-530 mm	520-600 mm	595-675 mm
Seat Width	485 mm	485 mm	485 mm
Seat Depth	385-480 mm	385-480 mm	385-480 mm
Seat Height	390-530 mm	390-530 mm	390-530 mm

HÅG H05 5200 - Small Back

HÅG H05 5200 has a low back and is fully upholstered, standard 150 mm gas lift and silver footbase.

HÅG H05 5300 - Medium Back

HÅG H05 5300 has a medium height back and is partially upholstered, adjustable armrests, standard 150 mm gas lift and silver footbase.

HÅG H05 5600 - High Back - Upholstered

HÅG H05 5600 has a high back and is fully upholstered, adjustable armrests, standard 150 mm gas lift and silver footbase.

Options / Accessories

- SwingBack armrests
- Headrest
- Black or silver footbase
- Castors for hard or carpeted floors
- Higher gas stem
- StepUp footrest

0503401	HAG H05 5200 No Armrests Grp 1	£430.00
0503801	HAG H05 5300 Adj Armrests Grp 1	£547.00
0503411	HAG H05 5600 Adj Armrests Grp 1	£613.00
0505001U	H05 Upgrade to Swingback Armrests	£60.00
0505021	HAG H05 Headrest 5200/5400/5600 Grp 1	£133.00
0505011	HAG H05 Headrest 5100/5300/5500 Grp 1	£122.00
0510101	HAG StepUp	£80.00

Colour Options (please select when ordering)

Stock

Black
EXR009

Blue
EXR024

10 Year
Guarantee
9hr use

24/7
5 Year
Guarantee



10 Year
Guarantee
9hr use

24/7
5 Year
Guarantee

HÅG Futu

Elegant & intelligent.

HÅG Futu has an adjustable lumbar support and seat-depth setting. The chair is delivered with the specially designed FutuKnit textile on the backrest and your choice of FutuKnit or HTC on the seat. The chair features inBalance™ technology with balanced floating forward and backward tilt. Tilt resistance is adjustable and lockable. Height and breadth-adjustable armrests are optional. Standard 165 mm gas lift. Footbase with footrest in silver or black. Castors for hard or carpeted floors.

Chair Model	Futu
Backrest Height	600 mm
Seat Width	485 mm
Seat Depth	380-460 mm
Seat Height	400-550 mm

Options / Accessories

- Adjustable Armrests
- Neckrest
- Black or silver footbase
- Castors for hard or carpeted floors
- Higher gas stem
- StepUp footrest

0520001	HAG Futu Futuknit No Armrests	£438.00
0520031	HAG Futu Back & Total Colour Seat	£450.00
05020032	HAG Futu Black Plastic Adj Armrests	£42.00

Colour Options (please select when ordering)

Futuknit Fabric Options

Black
FTU 001

Green
FTU 006

Red
FTU 005

Blue
FTU 003

Off White
FTU 008

Positiv Plus

Think Positiv to experience world-class ergonomic design and functionality at an affordable price.

The Positiv Plus offers the sort of sophisticated controls, adjustability and durability normally only to be found in more expensive chairs.

- Unique ergonomic multi-featured seat system:
 - › Hinge-fronted seat to ease pressure on legs in reclined mode and offer additional seat tilt in forward mode
 - › Telescopic hand-wheel seat slide adjustment with 78 mm of movement
- Sophisticated under-seat control providing maximum adjustability
- Modern contoured backrests with subtle curves
- Unique Ergo-Slide backrest height adjustment system allowing easy, smooth control from the seated position
- Replaceable moulded-foam seat cushions
- Top action, safety gas lift guaranteed to 150 kg
- Inflatable lumbar panel for additional support
- Available with three different backs: medium, high or slim back

Positiv Plus - Medium Back

Measurements:

- **Backrest (WxH):** 435 x 490-570 mm
- **Seat (WxD):** 500 x 440-525 mm
- **Seat height:** 480-610 mm

Positiv Plus - High Back

Same chair as the Medium back, but with a high back.

Measurements:

- **Backrest (WxH):** 435 x 610-690 mm
- **Seat (WxD):** 500 x 440-525 mm
- **Seat height:** 480-610 mm

Positiv Plus - Slim Back

Same chair as the Medium back, but with Slim back.

Measurements:

- **Backrest (WxH):** 485 x 550-670 mm
- **Seat (WxD):** 500 x 440-525 mm
- **Seat height:** 480-610 mm

Options / Accessories

Customise to suit your needs, work tasks and aesthetic preferences. Speak to one of our experts who can walk you through the options.

- Neckrest (9787703)
- Adjustable armrest - height, depth & width
- Coccyx cutout
- Memory foam
- Seat - small or XL versions
- Castor options available: carpeted floors, hard floors, semi-braked, brake loaded, brake unloaded and manual locking.
- Higher gas stem

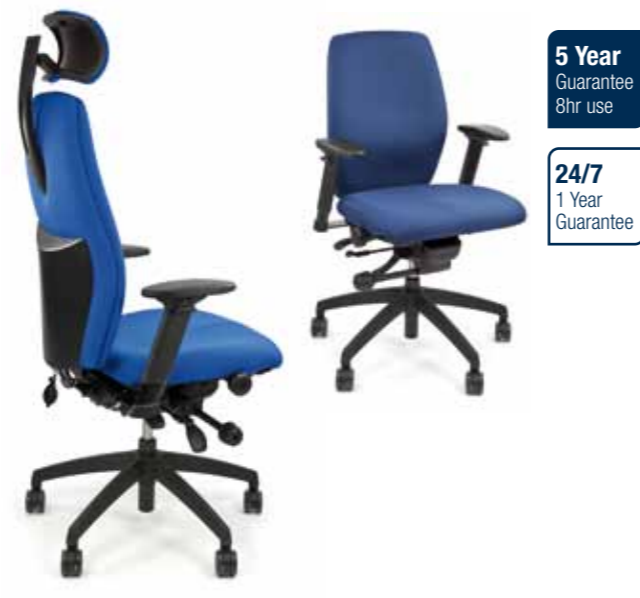

5 Year
Guarantee
8hr use

24/7
1 Year
Guarantee



Positiv Plus - Medium Back

Positiv Plus Complete - High Back



Positiv Plus - Slim Back

9787401	Positiv Plus Slim Back No Neck	£549.00
9787411	Positiv Plus Slim Back No Neck No Arms	£524.00
9787501	Positiv Plus Medium Back No Neck	£549.00
9787502	Positiv Plus Medium Back Complete	£584.00
9787511	Positiv Plus Medium No Neck No Arms	£524.00
9787601	Positiv Plus High No Neck	£599.00
9787602	Positiv Plus High Complete	£634.00
9787611	Positiv Plus High No Neck No Arms	£574.00

Colour Options (please select when ordering)

Stock

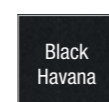

Non-stock (please allow 2-3 weeks)

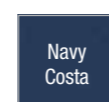

Positiv Range

A quality lower cost ergonomic chair with a range of optional customisations.

The Positiv range features a range of optional customisations to meet different needs. Our Positiv chairs are delivered fully assembled and ready to use.

Positiv R600

Positiv R600 has a radial back and is available in tall or medium, with choice of independent back angle adjustment.

Measurements - Medium back:

- **Backrest (WxH):** 430 x 520 mm
- **Seat (WxD):** 470 x 420 mm
- **Seat height:** 490-610 mm

Measurements - Tall back:

- **Backrest (WxH):** 450 x 545 mm
- **Seat (WxD):** 490 x 470 mm
- **Seat height:** 490-600 mm

Positiv U600

Positiv U600 has an upholstered back and is available in large or medium, with choice of independent back angle adjustment.

Measurements - Medium Back:

- **Backrest (WxH):** 450 x 440 mm
- **Seat (WxD):** 490 x 470 mm
- **Seat height:** 490-600 mm

Measurements - Tall back:

- **Backrest (WxH):** 450 x 600 mm
- **Seat (WxD):** 490 x 470 mm
- **Seat height:** 490-600 mm

Positiv S600

Positiv S600 has a square back and is available in large or medium, with choice of independent back angle adjustment.

Measurements:

- **Backrest (WxH):** 450 x 490 mm
- **Seat (WxD):** 500 x 490 mm
- **Seat height:** 420-530 mm

Options / Accessories

Customise to suit your needs, work tasks and aesthetic preferences. Speak to one of our experts who can walk you through the options.

- Adjustable armrests (9787100U)
- Retractable armrests (9787102U)
- Foldaway arms (9787101U)
- Seat slide (9787105U)
- Inflatable lumbar (9787106U)
- Polished base (9787103U)
- Neckrest - U600 only (9787108U)



5 Year
Guarantee
8hr use

24/7
1 Year
Guarantee



Positiv R600

Positiv U600



Positiv S600

9787038IN	Positiv R600 Medium Back	£195.00
9787002	Positiv R600 Tall Back Chair	£209.00
9787002IN	Positiv R600 Tall Back Independent Mech	£215.00
9787029	Positiv U600 Medium Back	£264.00
9787029IN	Positiv U600 Med Back Independant Mech	£269.00
9787004	Positiv U600 Tall Back Chair	£269.00
9787004IN	Positiv U600 Tall Back Independent Mech	£275.00
9787003	Positiv S600 Chair	£202.00
9787003IN	Positiv S600 Independent Mech	£199.00

Colour Options (please select when ordering)

Please allow 2-3 weeks

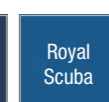
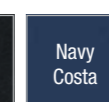
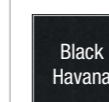

HÅG H09 Collection

More than an office chair.

HÅG H09 is an office chair that gives the feel of a private space – creating an environment of its own that further stimulates your concentration and creativity. HÅG H09 has been developed with your stringent demands on visual design and ergonomics in mind. For this reason, the designer has identified a varied spectrum of styles, materials and colours from the most modern and exclusive of palettes. See the world with new eyes.

The HÅG H09 range feature HÅG's 'BalancedMovementMechanism' adjustable seat height and seat depth. An adjustable lumbar cushion provides extra comfort and optimal support. Tilt resistance is adjustable and lockable.

HÅG H09 Classic 9130

HÅG H09 Classic 9130 has a high back and an adjustable headrest. HÅG H09 is delivered with multi-functional TiltDown armrests in black leather as standard. The footbase/gas lift is available in matte black or polished aluminium.

Measurements:

- **Backrest (WxH):** 480 x 1060 mm
- **Seat depth:** 395-515 mm
- **Seat height:** 390-530 mm

HÅG H09 Inspiration 9220 / 9230

HÅG H09 Inspiration 9220 has a medium back. HÅG H09 Inspiration 9220 is delivered with a mesh back in Space or Lumina. The seat is available in Elmosoft leather or in shiny worsted Tex Uni wool.

Measurements:

- **Backrest (WxH):** 480 x 1060 mm (790 mm without headrest)
- **Seat depth:** 395-515 mm
- **Seat height:** 390-530 mm

HÅG H09 Excellence 9320 / 9330

HÅG H09 Excellence 9320 has a medium back. The 9330 version comes with an adjustable headrest. The footbase/gas lift is available in matte black or polished aluminium. HÅG H09 Excellence 9320 is available with the seat and back in Elmosoft leather or in exclusive Vadal Uni wool.

Measurements:

- **Backrest (WxH):** 480 x 1060 mm (790 mm without headrest)
- **Seat depth:** 395-515 mm
- **Seat height:** 390-530 mm

HÅG H09 Meeting Inspiration 9272

HÅG H09 Meeting Inspiration 9272 has a high back. The footbase/gas lift is available in matte black or polished aluminium. The footbase/gas lift is available in matte black or polished aluminium. HÅG H09 Inspiration 9272 is delivered with a mesh back in Space or Lumina. Armrests are optional.

Measurements:

- **Backrest (WxH):** 600 x 570 mm
- **Seat depth:** 475 mm
- **Seat height:** 385-520 mm



HÅG

10 Year Guarantee
9hr use

24/7
5 Year Guarantee



HÅG H09 Classic 9130

HÅG H09 Inspiration 9230



HÅG H09 Excellence 9320

HÅG H09 Meeting 9272

0501201	HAG H09 Classic High Back Grp 1	£1,186.00
0501602	HAG H09 Excellence High Back Elmo Soft	£1,684.00
0501502	HAG H09 Excellence Med Back Elmo Soft	£1,438.00
0501401	HAG H09 High Back Inspiration Tex	£1,148.00
0501301	HAG H09 Med Back Inspiration Tex	£1,015.00
0501701	HAG H09 Meeting Inspiration Tex	£595.00
0501801	HAG H09 Meeting Excellent Elmo Soft	£953.00

Colour Options (please select when ordering)

Leather	Tex / Shimmer Fabric		Xtreme		
Elmosoft Black	Shimmer Space	Shimmer Lumina	Tex Grey	Black EXR009	Blue EXR024



24/7
2 Year Guarantee

KAB Controller 24hr

A 24-hour chair for primary use in surveillance and control stations. Also ideal for deluxe office environments.

The standard version features a robust leather/fabric combination, providing maximum comfort and durability for 24/7 usage.

- Height and backrest angle adjustment
- Air lumbar
- Headrest and high backrest
- Tip-up comfort armrest
- Seat tilt, side tension
- Body contoured cushions

9792000	KAB Controller 24 Hour Leather/Fabric	£710.00
---------	---------------------------------------	---------



1 Year Guarantee
8hr use

BodyBilt

The BodyBilt provides exceptional comfort with upper and lower back support.

- Adjustable air lumbar support
- Backrest (HxW): 560 x 545 mm
- Seat (WxD): 660 x 533 mm
- Armrest height, angle and width adjustment
- Seat slide adjustment
- Seat tilt adjustment and tension control
- Guaranteed up to 227 kg

5525	Bodybilt Big & Tall 2500 Series Black	£1,099.00
5526	Bodybilt Big & Tall 3500 Series Black	£1,199.00



24/7
3 Year Guarantee

BE-GE 24hr 852

BE-GE 852 is a robust operator chair for 24 hour working environments. The seat has many different adjustments, which allows you to easily adjust and vary your sitting position during long and demanding working hours.

- Adjustable backrest height
- Lumbar support
- Standard headrest
- Height adjustment: 500-620 mm
- Length adjustment of seat: 100 mm
- Tension adjustment
- Control for tilting the chair 8 degrees forward from horizontal position

9792200	Be-Ge 852 Chair	£999.00
---------	-----------------	---------



5 Year Guarantee
8hr use

Score MaXX

This robust chair is especially developed for heavier people (up to 250 kg).

- Adjustable back height and angle
- Available in small, medium and large
- Seat
 - Small (WxH): 500 x 530 mm
 - Medium (WxH): 575 x 530 mm
 - Large (WxH): 650 x 530 mm
- Back
 - Small (WxH): 460 x 500 mm
 - Medium (WxH): 460 x 500 mm
 - Large (WxH): 560 x 500 mm

3809112	Score MaXX Chair - Small	£1,247.00
3809113	Score MaXX Chair - Medium	£1,286.00
3809114	Score MaXX Chair - Large	£1,325.00



5 Year Guarantee
8hr use

Grahl DUO-BACK Type 11

DUO-BACK is the office chair which offers you extraordinary lasting seated comfort due to the flexible dual backrest whose parts move individually of each other. DUO-BACK backrest has been proven to provide up to 50% less pressure on the spinal column.

- Sliding seat adjustment
- Weight tension adjustment
- Independently width adjustable DuoBack backrest pads
- A13 armrests with height adjustable and swivel/slide top pads (optional)

9705300	Duoback Type 11	£539.00
9705301	Duoback Type 11 with Arms	£664.00
9705302	Duoback Type 11 with Forward Tilt	£571.00
9705303	Duoback Type 11 with Forward Tilt & Arms	£696.00



5 Year Guarantee

Kango Stand Up Stool

The Kango Stand-Up Stool is specially designed for industry and laboratory use to allow users to stand at higher workstations, supporting the weight of the user.

- Veritable ergonomic design
- Allows user to work while standing, relieved of two thirds of body weight
- Extremely stable, easy to move
- Takes up little floor space, does not interfere with user movements
- Weight capacity: 120 kg
- Height range: 700-900 mm

9710101	Kango Stand Up Stool	£199.99
---------	----------------------	---------



5 Year Guarantee
8hr use

Score 4400 Pro

The ideal solutions for Industry, Laboratory & Medical environment. The 4400 Line Pro models embody the very latest thinking in ergonomics and workplace design. A good sitting position is less tiring and promotes concentration and better performance. With an aluminium base and polyurethane seat and back.

- Height range: 440-570 mm
- Adjustable seating and back angle
- Available with either fixed or adjustable sitting angles
- Available in stainless steel for food environments
- ESD option available. Please call for further information

3809115	Score 4400 Pro No Arms Adj Angle	£392.00
3809116	Score 4400 Pro No Arms Fixed Angle	£372.00



5 Year Guarantee

Score Sit-Stand Stool Steady

The Sit-Stand stool provides the solution for work that requires alternate sitting and standing positions. Also they are ideal for workplaces where there is a lack of leg space.

It is easily adjustable so finding the correct height is simple, meaning you are able to work comfortably and without strain.

- Adjustable sitting height and seat angle
- ESD version available
- Height adjustment 660-830 mm
- Work surface height 900-1000 mm

3809119	Sit Stand Stool Steady	£215.00
---------	------------------------	---------



5 Year Guarantee

Wave Stool

The innovative design of the Wave Stool is a new alternative to the kneeling chair that encourages the user to sit correctly by encouraging forward pelvic tilt through a gentle seat angle, which lets the thighs slope down forcing support directly below the spine and taking pressure off the discs. Choice of 6 colours available: Black, Green, Burgundy, Blue, Grey and Royal.

- Short: Users under 5 foot 2 inches
- Medium: Users 5 foot 2 inches - 5 foot 8 inches
- Tall: Users 5 foot 9 inches - 6 foot 3 inches
- Extra tall: Users above 6 foot 3 inches

97581000	Wave Stool Low (Select Colour)	£185.00
97582000	Wave Stool - Medium (Select Colour)	£185.00
97583000	Wave Stool - Tall (Select Colour)	£190.00
97584000	Wave Stool - Extra Tall (Select Colour)	£195.00



5 Year Guarantee

Salli Multi Adjuster

The development of the saddle chair has been formed around the sound ergonomics of the riding saddle. The ergonomic saddle chair improves posture, soothes backaches and stands out as a distinctive piece of furniture at home or in the office.

- Divided seat with adjustable seat width
- Legs are splayed to between 60° and 90°. Divided seat reduces pressure on the genital area for increased comfort.
- Hand controlled height and inclination adjustment with gas spring.
- Can be personalised to different user heights.

9739000	Salli Multiadjuster Chair Black Leather	£449.00
---------	---	---------



2 Year Guarantee

Putnams Kneeling Stool

This product promotes fatigue-free sitting and correctly aligns the spine. Ideal for home and office use and is fully adjustable with castors for easy movement. They are made of a beech wood and the seat and kneeler come in a variety of colours.

- Multi-swivel castors
- Seat size (WxLxD): 450 x 390 x 50 mm
- Knee pad size (WxLxD): 370 x 490 x 80 mm
- Coccyx version available

9793000BLA	Putnams Standard Kneeling Chair Black	£125.13
9793000BLU	Putnams Standard Kneeling Chair Blue	£125.13
9793000GRE	Putnams Standard Kneeling Chair Grey	£125.13
9793000BLU	Putnams Standard Kneeling Chair Blue	£125.13



HÅG

10 Year Guarantee
9hr use

HÅG H04 4470 / H05 5370 Communication

HÅG H04 / H05 Communication is perfect, not only as a visitor's chair but also as a seating solution for meeting rooms. HÅG H04 / H05 Communication is a meeting room chair to match your office chair. HÅG H05 Communication features the unique rocking mechanism which encourages movement and variation in the same way as the office chair.

- HÅG H04 4470 Communication has a medium height back. The skid-base is available in two colours, black and silver. Armrests are optional.
- HÅG H05 5370 has a partially upholstered medium height back. Legs are available in two colours, black and silver. Legs in polished aluminium and armrests are optional. Also available fully upholstered.

0505611	HAG H04 Comm 4470 No Arms Grp 1	£282.00
0504301	HAG H05 Comm 5470 No Arms Grp 1	£289.00



HÅG

10 Year
Guarantee

HÅG Conventio Wing

Meeting and conference chairs.

A dynamic chair specially designed for meetings and conferences. The built-in rocking mechanism inspires variation and movement, enhancing colleagues and audiences blood circulation, mental focus and performance. HÅG Conventio Wing is made from light materials than can cope with rough treatment. Its easy maintenance makes the chair particularly well suited for use in places such as schools, universities, libraries, canteens, cafés, meeting rooms, hotels and conference centres. The chairs can be stacked 10-15 chairs high. Placing out neat rows of chairs is made easy by the linking mechanism.



HÅG Conventio Wing 9811



HÅG Conventio Wing 9821



HÅG Conventio Wing 9831



HÅG Conventio Wing 9832

0500111	HAG Conventio Wing 9811	£114.00
0500131	HAG Conventio Wing 9821 Grp 1	£138.00
0500151	HAG Conventio Wing 9831 Grp 1	£170.00
0500161	HAG Conventio Wing 9832 Grp 1	£203.00
0500171	HAG Conventio Wing Armrests	£33.00



9520



9512

HÅG

10 Year
Guarantee

HÅG Conventio

Time spent in meeting rooms can often represent more of a burden than normal office time. For this reason, all rooms should be filled with meeting room chairs that inspire variation and movement. HÅG Conventio is the chair that is revolutionising seating comfort standards, not only in meetings and conferences but also in places such as canteens, cafés, libraries and homes.

HÅG Conventio 9520

HÅG Conventio 9520 is delivered with a fully upholstered seat and back. Removable covers, aluminium legs are available in either black or silver and armrests are optional. Can be stacked up to 15 high.

HÅG Conventio 9512

HÅG Conventio 9512 has a plastic footbase and a 150 mm gas lift. The seat and front part of the backrest are partially upholstered, the rear of the backrest is plastic. Removable seat and back covers and armrests are optional.

0507401	HAG Conventio 9520 No Arms Grp 1	£188.00
0507311	HAG Conventio 9512 + Arms Grp 1	£244.00
0507301	HAG Conventio 9512 No Arms Grp 1	£211.00



Sideways 9730



Sideways 9740

HÅG

10 Year
Guarantee

HÅG Sideways

This revolutionary meeting room chair is comfortable to sit in no matter how you twist and turn. The seat is designed to provide maximum seating comfort while allowing freedom of movement. The armrest provides support, lessening the burden on the shoulders. It sweeps around the back of the chair, embracing the user and enabling sensible sideways seating. The back of the HÅG Sideways is available in four different colours: black, ochre, sand and olive.

HÅG Sideways 9730

HÅG Sideways 9730 has a plastic back. The skid base is made of stainless steel.

HÅG Sideways 9740

HÅG Sideways 9740 has an upholstered seat and back. Skid-base in stainless steel.

0500501	HAG Sideways 9730 Grp 1	£313.00
0500701	HAG Sideways 9740 Grp 1	£355.00



Desking & Furniture

Desks • Pedestals • Storage • Accessories

Stand up for your health

The human body wasn't designed to sit for long periods. Yet millions of people do just that, day in and day out, at work putting undue strain on their lumbar spines.

Fortunately we've got the answer. Our height adjustable desks allow people to change regularly between a seated working position and a standing one. This has a number of proven benefits.

- Improved blood circulation
- Improved concentration
- Relief from a static posture
- Flexibility to adjust your working position to the task in hand
- Ability to move and change position without interrupting work flow
- Increased alertness and productivity

Our high quality, functional workstations are available for individual users through to complete contract installations.

So don't just sit there – stand up for your health!

DeskRite 500

Electric Height-Adjustable Desking.

Simply the best range of electric 'sit-to-stand' desking. State-of-the-art electronics make changing the desk height smooth and simple, while sophisticated software guarantees the desk is always perfectly level. It's even clever enough to compensate for uneven loads on the desk top.

- 3-Day turnaround from stock
- Speak to one of our experts who can walk you through the options

Available in four desk shapes: writing, stance, wave and corner

Writing

The Writing desk is ideal for conventional use with flat screen monitors, laptops or traditional CRT monitors.

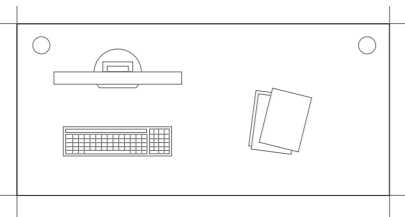

Stance

Ultimate layout for use with flat screen monitors or laptops combining with a percentage of clerical work.

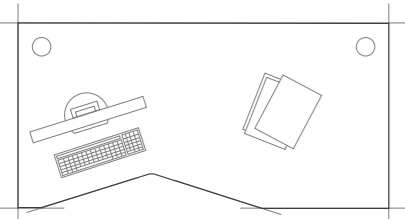

Wave

The perfect corner desk. A straight edge allows you to position yourself close to the desk preventing the need to lean forward to reach your keyboard.

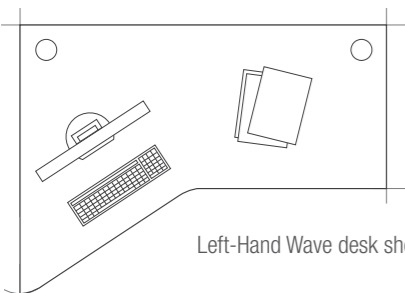

Corner

Ideal for creating extra work space. Just make sure the armrests on your chair do not prevent you from sitting close enough to the desk.

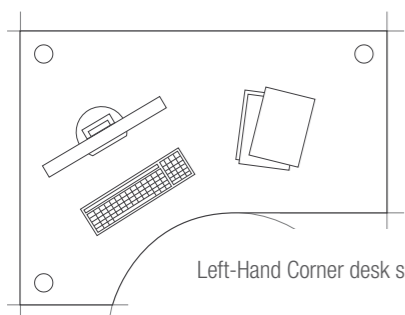

Writing (Stock items shown in bold)

Width mm	Finish	Code 800 mm (d)	Price 800 mm (d)	Code 1000 mm (d)	Price 1000 mm (d)
800	Maple	090111110	£905.00	-	-
800	Beech	090121110	£905.00	-	-
800	Veneer	090131110	£1,009.00	-	-
1000	Maple	090112110	£915.00	090112210	£929.00
1000	Beech	090122110	£915.00	090122210	£929.00
1000	Veneer	090132110	£1,019.00	090132210	£1,035.00
1200	Maple	090113110	£925.00	090113210	£939.00
1200	Beech	090123110	£925.00	090123210	£939.00
1200	Veneer	090133110	£1,029.00	090133210	£1,045.00
1400	Maple	090114110	£935.00	090114210	£949.00
1400	Beech	090124110	£935.00	090124210	£949.00
1400	Veneer	090134110	£1,039.00	090134210	£1,055.00
1600	Maple	090115110	£945.00	090115210	£959.00
1600	Beech	090125110	£945.00	090125210	£959.00
1600	Veneer	090135110	£1,049.00	090135210	£1,065.00
1800	Maple	090116110	£965.00	090116210	£985.00
1800	Beech	090126110	£965.00	090126210	£985.00
1800	Veneer	090136110	£1,069.00	090136210	£1,089.00
2000	Maple	090117110	£989.00	090117210	£1,005.00
2000	Beech	090127110	£989.00	090127210	£1,005.00
2000	Veneer	090137110	£1,095.00	090137210	£1,109.00

Stance (Stock items shown in bold)

Size mm	Finish	Code Left Stance	Code Right Stance	Price 800 mm
1600 x 800	Maple	090215111	090215112	£965.00
1600 x 800	Beech	090225111	090225112	£965.00
1600 x 800	Veneer	090235111	090235112	£1,015.00
1800 x 800	Maple	090216111	090216112	£985.00
1800 x 800	Beech	090226111	090226112	£985.00
1800 x 800	Veneer	090236111	090236112	£1,089.00
2000 x 800	Maple	090217111	090217112	£1,005.00
2000 x 800	Beech	090227111	090227112	£1,005.00
2000 x 800	Veneer	090237111	090237112	£1,055.00

Finishes

Table top Frame

Beech	Maple	Silver	Black
-------	-------	--------	-------

5 Year Guarantee



Wave (Stock items shown in bold)

For right hand Wave desk, please substitute the last digit to a '2'.

Width mm	Finish	Code 1000 mm (d)	Price 1000 mm (d)	Code 1200 mm (d)	Price 1200 mm (d)
1400	Maple	-	-	090314311	£1,015.00
1400	Beech	-	-	090324311	£1,015.00
1400	Veneer	-	-	090334311	£1,119.00
1600	Maple	090315211	£999.00	090315311	£1,015.00
1600	Beech	090325211	£999.00	090325311	£1,015.00
1600	Veneer	090335211	£1,105.00	090335311	£1,119.00
1800	Maple	090316211	£1,019.00	090316311	£1,035.00
1800	Beech	090326211	£1,019.00	090326311	£1,035.00
1800	Veneer	090336211	£1,125.00	090336311	£1,139.00
2000	Maple	090317211	£1,039.00	090317311	£1,055.00
2000	Beech	090327211	£1,039.00	090327311	£1,055.00
2000	Veneer	090337211	£1,145.00	090337311	£1,159.00

Corner (Stock items shown in bold)

For right hand Corner desk, please substitute the last digit to a '2'.

Width mm	Finish	Code 1000 mm (d)	Price 1000 mm (d)	Code 1200 mm (d)	Price 1200 mm (d)
1400	Maple	-	-	090414311	£1,015.00
1400	Beech	-	-	090424311	£1,015.00
1400	Veneer	-	-	090434311	£1,119.00
1600	Maple	090415211	£999.00	090415311	£1,015.00
1600	Beech	090425211	£999.00	090425311	£1,015.00
1600	Veneer	090435211	£1,105.00	090435311	£1,119.00
1800	Maple	090416211	£1,035.00	090416311	£1,035.00
1800	Beech	090426211	£1,019.00	090426311	£1,035.00
1800	Veneer	090436211	£1,125.00	090436311	£1,139.00
2000	Maple	090417211	£1,039.00	090417311	£1,055.00
2000	Beech	090427211	£1,039.00	090427311	£1,055.00
2000	Veneer	090437211	£1,145.00	090437311	£1,159.00

Specification

Speed:	43 mm / second
Liftable weight:	Max 140 kg
Height Range:	680-1800 mm
Top thickness:	MFC: 25 mm chipboard with 3 mm edges Veneer: 25 mm MDF with straight edges
Warranty:	5 years

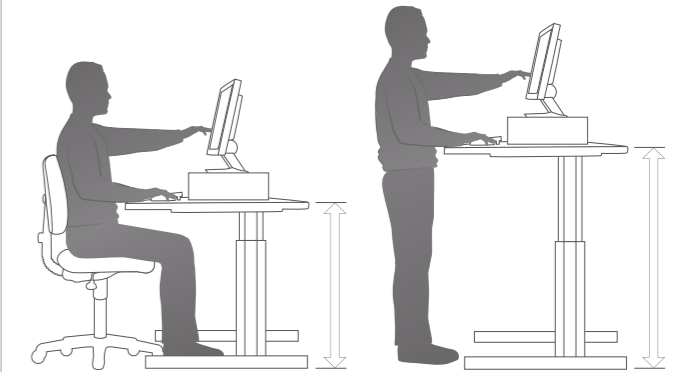

Options

Frame options

Silver aluminium frame as standard. Also available in black frame. For black frame, substitute the second to last digit of the code with a '2'.

Table top options

Choose from Maple or Beech in either MFC or veneer. For other options or finishes, please call for details.

Electric switch

Options (standard pictured):

- Memory allows 2 users to have preset heights (POA)
- Memory with digital display (POA)

Cable tray

- Cable tray comes as standard

Modesty panel

Silver	Black	Width	Price
093411	093412	800 mm	£89.00
093421	093422	1000 mm	£89.00
093431	093432	1200 mm	£99.00
093441	093442	1400 mm	£99.00
093451	093452	1600 mm	£99.00
093461	093462	1800 mm	£105.00
093471	093472	2000 mm	£105.00



Up-Down Switch



Cable Tray



Modesty Panel



DeskRite 300

Basic electric height-adjustable desking.

Our basic electric range is available in two desktop shapes. Choose between our standard rectangular writing desktop and our 'cockpit' unhandred corner workstation. A new improved and simplified design enables you to adjust the desk height quickly and is also easier to install.

- Height range: 680-1290 mm
- Maximum liftable weight: 60 kg

Writing

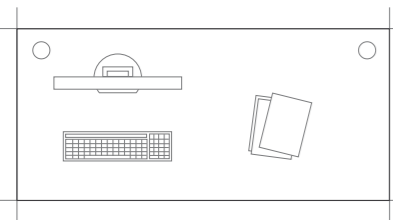

The Writing desk is ideal for conventional use with flat screen monitors, laptops or traditional CRT monitors.

Cockpit

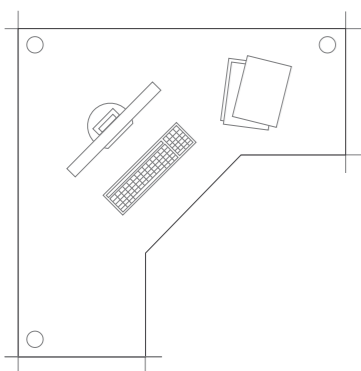

Allows you to position yourself close to the desk with a straight edge. The 'Cockpit' prevents the need to lean forward to reach your keyboard.

070118110	DeskRite 300 Elec Map/Sil 110x80	£549.00
070113110	DeskRite 300 Elec Map/Sil 120x80	£559.00
070114110	DeskRite 300 Elec Map/Sil 140x80	£569.00
070115110	DeskRite 300 Elec Map/Sil 160x80	£579.00
070116110	DeskRite 300 Elec Map/Sil 180x80	£589.00
070514413	DeskRite 300 Cockpit Map/Sil	£1,049.00

Finishes

Desktop Frame



5 Year Guarantee



DeskRite 200

Crank height-adjustable desking.

Our crank height adjustable DeskRite 200 range is available in five rectangular desk sizes and represents the most economical way to provide height adjustable desking.

- Height range: 720-1180 mm
- Maximum liftable weight: 60 kg

Writing

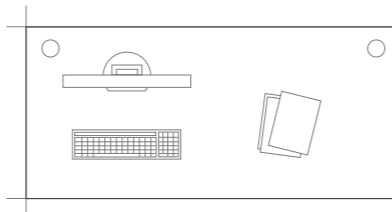

Ultimate layout for use with flat screen monitors or laptops combining with a percentage of clerical work.

060118110	DeskRite 200 Crank Map/Sil 110x80	£379.00
060113110	DeskRite 200 Crank Map/Sil 120x80	£389.00
060114110	DeskRite 200 Crank Map/Sil 140x80	£399.00
060115110	DeskRite 200 Crank Map/Sil 160x80	£409.00
060116110	DeskRite 200 Crank Map/Sil 180x80	£419.00

Finishes

Desktop Frame

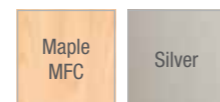

5 Year Guarantee

Sense Desking

Connect - Build - Play - Grow.

Sense is a unique system of office workstations and accessories from Herman Miller. At its heart is a groundbreaking design that requires absolutely no tools for assembly or dismantling. Components simply lock, click, or snap into place, so it's quick to order, quick to build and easy to reconfigure.

Shape options

There's a wide range of table shapes and sizes – rectangular, wave and 120 degree. These can be used alone, or be extended to create larger configurations featuring extensions, returns, satellites and meeting ends.

Size options

- 800(w) up to 180(w) mm
- 600(d) and 800(d) mm

Accessories

There's also a full range of support products, including screens, tool bars, CPU holders, shelves, cable management products and paper-handling accessories.



Table leg options

- Height adjustable legs available
- Available in Chalk White, Metallic Silver, Thorium Grey and Stainless Steel



Table Top Finishes (please select when ordering)

Swatch book available on request.

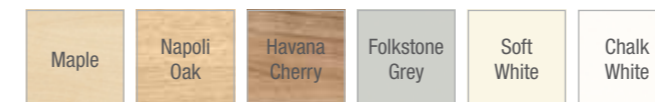

Herman Miller



Desks

0012513	Sense 80 x 80cm Fixed Height Maple MFC	£325.00
0012514	Sense 100 x 80cm Fixed Height Maple MFC	£334.00
0012515	Sense 120 x 80cm Fixed Height Napoli Oak	£343.00
0012516	Sense 120 x 80/60cm Wave Fix Hgt SIL MFC	£340.00

Accessories

0019201SIL	Pinnable Tablet Silver - 2 Pack	£84.00
0012566	Sense A4 Paper Tray 2 per pack Silver	£33.00
0019202SIL	A3 Paper Tray (1 Pack)	£22.00
0012565	Sense Binder Bin 120mm 2 per pack Silver	£35.00
0019208SIL	Binder Bin 240mm (1 Pack)	£23.00
0019203SIL	Sense Mini Shelf (2 Pack) Silver	£29.00
0019209SIL	Mini Shelf 360mm (1 Pack)	£19.00
0019210SIL	CPU Carrier	£47.00
0019211SIL	CPU Shelf (2 Pack)	£16.00
0018200	Sense 4 Power Module	£62.00
0018201	Sense 3 Power Module + Switch Module	£58.00
0018203	Sense 2 Power + 2 x Data Module	£97.00
0018204	Sense 4 x Data Module	£106.00

Homeworking Furniture Range

Our basic furniture range, ideal for homeworkers.

Our homeworking furniture offers a modern look and feel for any home or small office environment. Manufactured from powder coated steel and MFC laminate. The range offers a wide number of storage options from open bookcases to mobile pedestals.



Dynamic

Crescent

Dynamic Rectangular Desk

Ultimate layout for use with flat screen monitors or laptops combining with a percentage of clerical work.

Crescent Corner Desk

Ideal for creating extra work space. Just make sure the armrests on your chair do not prevent you from sitting close enough to the desk.

9722000	Dynamic Rectangular Desk 120x80cm ELM	£199.27
9722002	Dynamic Rectangular Desk 160x80cm ELM	£215.87
9722010	Crescent Desk 160x120 R ELM	£264.18
9722011	Crescent Desk 160x120 L ELM	£264.18
9722012	Leg Support (for Crescent desk if no D/H pedestal is used)	£23.12



Storage Units

25mm Thick Elm MFC

1 shelf option (WxDxH): 890 x 420 x 1500 mm

2 shelf option (WxDxH): 890 x 420 x 1850 mm

Pull-out Frame accessory (WxD): 850 x 360 mm

9722021	Storage Unit 1 Shelf	£294.37
9722026	Storage Unit 2 Shelf	£338.15
9722025	Storage Acc - Pull Out Frame Silver	£89.07



Under Desk Mobile

Desk Height

MFC Pedestals

Under Desk Mobile Pedestals

Elm MFC - Lockable

1 Drawer / 1 filing option (WxDxH): 410 x 550 x 565 mm

3 Drawer option (WxDxH): 410 x 550 x 565 mm

Desk Height Pedestals

Elm MFC - Lockable

2 Drawer 1 filing option (WxDxH): 410 x 600 x 730 mm

4 Drawer option (WxDxH): 410 x 600 x 730 mm

9722017	Under Desk Ped 1 Draw 1File ELM	£212.85
9722015	MFC Mobile Pedestal 3 Drawer ELM	£215.87
9722013	MFC Desk Height Ped 2 Drawer 1 File ELM	£285.31
9722030	MFC Desk Height Ped 4 Drawers ELM	£280.79



Under Desk Mobile

Desk Height

Steel Pedestals

Steel Under Desk Pedestals

Steel Pedestals - Lockable

1 Filing / 1 Box Drawer option (WxDxH): 420 x 565 x 495 mm

1 Filing / 2 Box Drawer option (WxDxH): 420 x 565 x 645 mm

Available in: silver, black, or slate

Steel Desk Height Pedestals

Steel Pedestals - Lockable

2 Filing Drawers option (WxDxH): 420 x 565 x 695 mm

1 Filing / 2 Box Drawers option (WxDxH): 420 x 565 x 695 mm

Available in: silver, black, or slate

9785101	Mobile 1 File/1 box Drawer Sil	£212.00
9785102	Mobile 1 File/2 box Drawers Sil	£221.00
9785103	Freestand 2 File Drawers Sil	£232.00
9785104	Freestand 1 File/2 Box Drawers Sil	£232.00

Input devices

Keyboards • Mice • Tablets

Choosing a computer mouse and keyboard is as important as choosing a pair of trainers. They need to be comfortable and not cause you pain after a lot of use!

Most standard mice fail on both counts. That's why we recommend you go for an ergonomically-designed device, like our recently-introduced Penguin vertical mouse, that will not only help shield you from potential strain injuries but also improve your productivity. A vertical mouse eliminates the need for forearm twisting and, in the case of the Penguin, allows you to switch hands regularly throughout the working day, avoiding overuse of the dominant hand.

Trackball, roller mice and centrally pointed input devices all reduce or eliminate the need for sideways or reaching arm movements and keep the user's hands in a more natural position.

We have long considered the standard computer keyboard design, with its right-sided integral number pad, to be flawed as it forces users to make uncomfortable stretching movements. Fortunately there are now plenty of alternatives.

Compact or short keyboards allow you to position the mouse much closer to you. Separate numeric pads can always be added if required. A number slide keyboard offers the best of both, acting as a compact when the integral number pad is hidden away and as a conventional keyboard once it is exposed. Split keyboards are probably the most ergonomically efficient, promoting a more natural positioning of the arms and hands and reducing fatigue.

Keyboards and mice are the devices you'll use the most, so it's important to get the right ones for your needs. If you're not sure which to choose, contact your local Posturite Account Manager who will be happy to advise, or call one of our helpful customer service advisers on 0845 345 0010.

The Knowledge

All the info you need to help you choose your keyboard

Mini Keyboards



Brand	Posturite	Ergostars	Microsoft
Model	Number Slide Arch	Saturnus	Compact Mini Keyboard
Price	From £49.95	From £49.95	From £19.95
Type	Mini	Mini	Mini
Wired or Wireless	Wired	Wired	Wireless
Wireless Connectivity	N/A	N/A	Radio
Windows Compatible	✓	✓	✓
Mac Compatible	✓	✗	✓
Plug & Play	✓	✓	✓
Dimensions (HxWxD mm)	33 x 330 x 180 (closed)	20 x 305 x 165	15 x 320 x 170
Pack Dimensions (HxWxD mm)	36 x 360 x 215	28 x 305 x 165	40 x 321 x 164

Specialist

Mobile



Brand	Freedom
Model	Large Keys
Price	From £54.95
Type	Specialist
Wired or Wireless	Wired
Wireless Connectivity	N/A
Windows Compatible	✓
Mac Compatible	✓
Plug & Play	✓
Dimensions (HxWxD mm)	50 x 480 x 185
Pack Dimensions (HxWxD mm)	35 x 496 x 202

Office Exercises

Why stretch?

No matter how well the workstation is designed, problems may arise where work organisation is poor or disrupted. Working at a computer often involves few changes in body position. This lack of movement can lead to muscular aches and pains.

Below are a selection of exercises to help reduce aches and pains in the workplace.

Reduce aches and pains

- Regularly vary work tasks, looking at organisation of the working day
- Break up 'on-screen' activities with micro-breaks – tasks which involve movement, stretching and changes to body position
- Trying standing during some tasks and moving away from the workstation, for short periods, where possible

Split Keyboards

Left Handed Keyboards



Microsoft	Goldtouch	Goldtouch	Fujitsu / Siemens	Left Handed	Evluent
Natural Ergonomic 4000	Adjustable Keyboard	Go! Travel	Split	Left Handed	Mouse Friendly
From £44.95	From £139.00	From £159.95	From £99.95	From £89.95	From £59.99
Full	Split	Split	Split	Full	Full
Wired	Wired	Wired	Wired	Wired	Wired
N/A	N/A	N/A	N/A	N/A	N/A
✓	✓	✓	✓	✓	✓
✓	✓	✓	✗	✓	✓
✓	✓	✓	✓	✓	✓
83 x 503 x 262	25 x 338 x 178	26 x 345 x 140	42 x 383 x 166	20 x 470 x 200	12 x 393 x 159
83 x 557 x 287	47 x 408 x 235	34 x 374 x 217	55 x 413 x 264	50 x 520 x 218	25 x 416 x 189

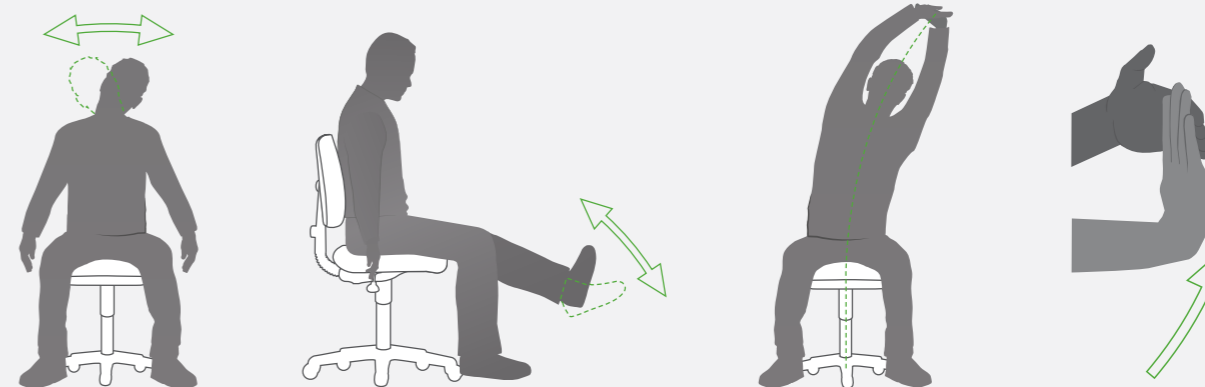

Neck & shoulders

Drop head slowly to one side, taking ear towards shoulder until stretch is felt. Hold for slow count of 10. Repeat 3 – 5 times to each side.

Leg & ankle

Lift ankle clear of floor. Alternately flex and extend ankle in a pumping action. Repeat 10 times with each ankle.

Back

Interlace fingers and lift arms above head, keeping elbows straight. Pressing arms back, slowly stretch to one side. Hold for slow count of 10. Repeat 3 – 5 times to each side.

Wrist, hand & forearm

Holding upper part of hand with other hand, slowly bend wrist down and then upwards until stretch is felt at each extreme. Hold each for slow count of 10. Repeat 3 – 5 times.



Posturite Number Slide Arch Keyboard

Compact keyboard with an integral number pad that easily slides out sideways (right hand side only) to expose the fully functioning number pad. Avoids the need to have an additional number pad.

- Dimensions (LxWxH): 330 closed/400 open x 180 x 33 mm
- Extra USB port at rear for mouse/pen drive
- Scroll bar below space bar for easy scrolling

9820000	Posturite Number Slide Arch Keyboard	£49.95
---------	--------------------------------------	--------



Ergostars Saturnus Keyboard & Numeric Keypad

The Ergostars Saturnus is a compact mini keyboard designed to be used alongside the matching number pad (optional extra). The keyboard combines ergonomics and design.

- Dimensions (LxWxH): 305 x 165 x 20 mm
- 2 x built-in USB ports

9735000	Ergostars Saturnus Silver Keyboard	£49.95
9735001	Ergostars Numeric Keypad with Calculator	£41.95



Compact Mini Keyboard

Ultra slim profile mini keyboard with internet hot keys. Suitable for normal desktop computers and laptop users. The narrow profile allows you to simply move the mouse closer to you for easier operation.

- Dimensions (LxWxH): 320 x 170 x 14.5 mm
- Ultra slim profile
- Supports multimedia with multi-functional hot keys

354301	Compact Mini Keyboard	£19.95
--------	-----------------------	--------



Microsoft Arc Wireless Keyboard

Meet the Arc Keyboard - with beautiful curves and a compact design. The Arc Keyboard is extremely portable and its comfortable domed keyset allows hands to comfortably rest in place while typing.

- Dimensions (LxWxH): 311 x 154 x 22 mm
- Stowable Nano Transceiver - Be free, with wireless freedom
- Lightweight and compact

9745118	Microsoft Arc Keyboard	£46.60
---------	------------------------	--------



Microsoft Natural Ergonomic Keyboard 4000

The Gull Wing design features a 14-degree gable, a natural arc and a curved key bed - bringing the keys closer to your fingers to reduce reach and unnecessary motion, while encouraging a more natural typing position.

- Dimensions (LxWxH): 503 x 262 x 83 mm
- Integrated palm rest
- Zoom in quickly and accurately with the intuitive Zoom feature.

354402	Microsoft Ergo 4000 Keyboard Black	£44.95
--------	------------------------------------	--------



Fujitsu Siemens Split Keyboard

This keyboard promotes the natural positioning of the user's arms and hands, thus making for fatigue-free operation. This is achieved by angling the two halves of the keyboard at 30 degrees to each other and by additionally incorporating a front-to-back inclination.

- Dimensions (LxWxH): 383 x 166 x 42 mm
- Keyboard slope range: 6° and 12° / lateral slope: 0°, 10° and 16°

9770000	Fujitsu Siemens Split Keyboard	£99.95
---------	--------------------------------	--------



Goldtouch Adjustable Keyboard

The Goldtouch Adjustable Keyboard is designed to properly straighten the wrists and arms while aligning with the shoulders to achieve a neutral typing posture. Available in black or white with additional Number Pad (optional).

- Dimensions (LxWxH): 338 x 178 x 25 mm

3549	Goldtouch Keyboard PS2/USB Black	£139.00
3548	Goldtouch Keyboard PS2/USB White	£149.95
3553	Goldtouch Black USB Numeric Pad	£67.95



Goldtouch Go! Travel Keyboard

The Goldtouch Go! Travel Keyboard is a compact keyboard that reduces or eliminates risk factors that lead to injury. It allows road warriors and mobile professionals to safely work wherever their job takes them.

- Dimensions (LxWxH): 26 x 345 x 140 mm
- Compact size allows for use in limited space environments
- Extra USB port at rear for mouse/pen drive

354901	Goldtouch Go Keyboard	£159.95
--------	-----------------------	---------



Large Keys Keyboard

This keyboard is designed to aid those with visual and dexterity difficulties.

- Dimensions (LxWxH): 480 x 185 x 50 mm - Large 2 x 2 mm keys!
- Available with either lowercase, uppercase, coloured or white keys

9876003	Large Coloured Keys Keyboard Lower Case	£54.95
9876002	Large Keys Keyboard White Lower Case	£54.95
9876001	Large Coloured Keys Keyboard Upper Case	£54.95
9876000	Large Keys Keyboard White Upper Case	£54.95



Left Handed Keyboard

This exceptional left handed keyboard fulfils a long felt need, providing the most convenient layout for people who are naturally left-handed. The design also maintains the ergonomic key positioning required in modern offices.

- Dimensions (LxWxH): 470 x 200 x 20 mm
- Number pad positioned on the left hand side
- Combi USB & PS/2

3545	Left Handed Keyboard	£89.95
------	----------------------	--------



Evoluent Mouse Friendly Keyboard

Most users use the mouse far more than the numeric keypad, so the Evoluent Mouse-Friendly Keyboard has a more sensible layout with the numeric keypad on the left so your mouse may be much closer on the right.

- Dimensions (LxWxH): 393 x 159 x 12 mm
- Eliminates stretching your arm to reach the mouse
- High quality key mechanisms with precision feel

83141	Evoluent Mouse-Friendly Keyboard	£59.99
-------	----------------------------------	--------



Freedom Pro Universal Bluetooth Keyboard

Dual Profile, Bluetooth portable keyboard. Portable and practical with additional functions, improved driver software and additional keys to give you even more control of your mobile device.

- Full 5 row keyboard with 75 keys
- Uses two AAA batteries
- Compatible with a large range of mobile devices including RIM Blackberry

9767100	Freedom Pro Universal Bluetooth Keyboard	£84.99
---------	--	--------

The Knowledge

All the info you need to help you choose your mouse

Vertical Mice



Brand	Posturite	Evoluent	Grip Mouse	AirO2bic Quill	Orthomouse
Model	Penguin	VerticalMouse	Grip Mouse	AirO2bic Quill	Orthomouse
Price	From £49.95	From £79.95	From £46.95	From £84.95	From £89.00
Type	Vertical	Vertical	Vertical	Vertical	Custom Fit
Right or Left-handed	Ambidextrous	Right/Left	Right	Right/Left	Right
Wired or Wireless	Both available	Both available	Wired	Wired	Wired
Wireless Connectivity	Radio	Radio	N/A	N/A	N/A
Windows Compatible	✓	✓	✓	✓	✓
Mac Compatible	✓	✓	✓	✓	✓
Rechargeable	✗	✗	N/A	N/A	N/A
Plug & Play	✓	✓	✓	✓	✓
Dimensions (HxWxD mm)	95 x 120 x 170 (large)	90 x 80 x 110	135 x 75 x 70	200 x 95 x 90	65 x 95 x 130
Pack Dimensions (HxWxD mm)	114 x 136 x 210	90 x 90 x 135	165 x 130 x 90	310 x 190 x 90	74 x 132 x 135

Graphics Tablets



Brand	3M	Wacom	Trust
Model	Anir	Pen & Touch	Slimline TB-6300
Price	From £125.15	From £84.99	From £49.99
Type	Joystick	Tablet	Tablet
Right or Left-handed	Right	Ambidextrous	Ambidextrous
Wired or Wireless	Both available	Wired	Wired
Wireless Connectivity	Radio	N/A	N/A
Windows Compatible	✓	✓	✓
Mac Compatible	✓	✓	✓
Rechargeable	✗	N/A	N/A
Plug & Play	✓	✓	✓
Dimensions (HxWxD mm)	110 x 80 x 130 (large)	10 x 250 x 180	13 x 306 x 290
Pack Dimensions (HxWxD mm)	130 x 135 x 130 (large)	60 x 305 x 245	64 x 370 x 320

Trackballs



Brand	Logitech	Logitech	Logitech
Model	M570 Trackball	Cordless TrackMan	Marble
Price	From £59.99	From £46.50	From £31.30
Type	Trackball	Trackball	Trackball
Right or Left-handed	Right	Right	Ambidextrous
Wired or Wireless	Wireless	Wireless	Wired
Wireless Connectivity	Radio	Radio	N/A
Windows Compatible	✓	✓	✓
Mac Compatible	✓	✓	✓
Rechargeable	✗	✗	✗
Plug & Play	✓	✓	✓
Dimensions (HxWxD mm)	46 x 95 x 145	65 x 90 x 150	50 x 90 x 165
Pack Dimensions (HxWxD mm)	75 x 246 x 250	80 x 205 x 225	70 x 205 x 225

Roller Mice



Traditional Mice



Brand	Contour	Contour	Trackbar	Logitech	Logitech	Logitech	Microsoft	Humanscale	HandShoeMouse	Perific	Hoverstop
Model	RollerMouse Free2	RollerMouse Pro2	Emotion	Performance MX	M305	Pilot	Arc	Switch	HandShoeMouse	Dual	Hoverstop
Price	From £199.99	From £179.00	From £49.95	From £89.00	From £29.99	From £10.95	From £43.08	From £62.00	From £90.00	From £99.00	From £49.99
Type	Rollerbar	Rollerbar	Rollerbar	Standard	Standard	Standard	Portable	Custom Fit	Custom Size	Handheld	Standard
Right or Left-handed	Ambidextrous	Ambidextrous	Ambidextrous	Right	Ambidextrous	Right	Ambidextrous	Ambidextrous	Right/Left	Right	Right
Wired or Wireless	Wired	Wired	Wired	Wireless	Wireless	Wired	Wireless	Wired	Both available	Wireless	Wired
Wireless Connectivity	N/A	N/A	N/A	Radio	Radio	N/A	Radio	N/A	Radio	Radio	N/A
Windows Compatible	✓	✓	✓	✓	✓	✓	✓	✓	✓	✓	✓
Mac Compatible	✓	✓	✓	✓	✓	✓	✓	✓	✓	✓	✓
Rechargeable	N/A	N/A	N/A	✓	✗	N/A	✗	N/A	✓	✗	N/A
Plug & Play	✓	✓	✓	✓	✓	✓	✓	✓	✓	✓	✓
Dimensions (HxWxD mm)	20 x 445 x 90	35 x 155 x 505	35 x 280 x 105	45 x 80 x 135	35 x 57 x 90	32 x 60 x 110	65 x 193 x 144	42 x 86 x 142	45 x 110 x 150	32 x 70 x 85	40 x 65 x 115
Pack Dimensions (HxWxD mm)	35 x 495 x 200	43 x 165 x 545	50 x 320 x 165	85 x 220 x 218	50 x 150 x 211	50 x 85 x 135	74 x 144 x 145	60 x 180 x 123	65 x 143 x 144	550 x 197 x 180	46 x 235 x 212

Penguin[®]

Ambidextrous Vertical Mouse



17.5 CM

Penguin

Ambidextrous Vertical Mouse

The Penguin offers computer users new standards of protection against Work Related Upper Limb Disorders. It provides a simple but revolutionary solution to many of the common health problems associated with repetitive use of the dominant hand by allowing both hands to share the workload. The base platform reduces the grip required to position the device without any loss of accuracy.

- Wired and wireless versions available.
- Available in small and standard sizes.

Naturally comfortable

The vertical alignment encourages a more ergonomic operating position.

Ambidextrous design

Central 'bow-tie' switch allows for easy transition between right and left handed use.

Easy-glide symmetrical base

Allows the user to rest either hand comfortably alongside the vertical structure, encouraging the use of the bigger muscles in the fore and upper arm to manoeuvre the mouse. Fine cursor control is still achievable with small hand and/or finger movements.

Performance laser tracking

Precision laser for accurate tracking.

Variable DPI [800-1200-1600]

Encourages controlled and precise operating movements.

Precision scroll wheel

For fast, accurate document scrolling including an auto-scroll feature.

Plug & Play USB 2.0

Windows XP, Windows 2000, Windows Vista, Windows 7, Mac OS X, Linux.



Which size?

The Penguin mouse is available in two sizes. To choose the correct one for you, measure your hand from the first crease on your wrist to the tip of your middle finger. If the measurement is less than 17.5 cm go for the small size. If it is greater than 17.5 cm, you will need the standard version.



9820100	Penguin Mouse - Small Wired	£49.95
9820101	Penguin Mouse - Standard Wired	£49.95
9820102	Penguin Mouse - Small Wireless	£64.95
9820103	Penguin Mouse - Standard Wireless	£64.95

www.posturite.co.uk

0845 345 0010



Evoluent Vertical Mouse 4

Avoids forearm twisting for comfort and good health. The patented shape supports your hand in an upright neutral position that generally avoids forearm twisting.

- Available in left or right hand and small right hand version
- Comfortable and easy to use - the shape is thoughtfully sculpted for uncompromised comfort and easy-to-reach programmable buttons.
- Improved thumb rest - the thumb rest has been reshaped to provide even more comfort over earlier versions.
- Now two thumb buttons - a new bottom thumb button provides greatly extended functionality when used with the included driver
- Extended lip prevents rubbing
- Adjustable laser sensor
- Pointer speed indicators

1401113	Evoluent Vertical Mouse 4 LH Wired	£99.95
1401112	Evoluent Vertical Mouse 4 RH Wired	£99.95
1401122	Evoluent Vertical Mouse 4 Small RH Wired	£99.95



Evoluent Vertical Mouse 3

The Evoluent Vertical Mouse has a patented shape that supports your hand in a neutral, relaxed handshake position which eliminates forearm twisting.

- Five buttons can be individually programmed to perform a variety of functions for speeding up common tasks with a single touch
- Optical sensor accurately tracks the movement of the mouse without a ball for improved reliability
- Wired and Wireless versions available

1401102	Evoluent Vertical Mouse 3 RH Wired	£79.95
1401101	Evoluent Vertical Mouse 3 RH Wireless	£114.95

support@posturite.co.uk



Grip Mouse

An ergonomically designed vertical mouse that eliminates arm twisting by keeping the forearm in a neutral position. The comfortable shape is better suited for larger hands and allows for a more relaxed position.

- Promotes good posture for the wrist and arm
- Black soft-grip sculptured base
- Designed to work with the natural shape and movement of your arm

9751000	Grip Mouse	£46.95
---------	------------	--------



HandShoe Mouse

Handshoe mouse provides excellent support to the hand and wrist allowing the hand to rest in a natural relaxed position. Left handed version available.

- Three sizes available to suit a range of users in wired or wireless

9861003	Handshoe Mouse Wired R/H Small	£90.00
9861103	Handshoe Mouse Wireless R/H Small	£108.00
9861002	Handshoe Mouse Wired R/H Medium	£90.00
9861102	Handshoe Mouse Wireless R/H Medium	£108.00
9861001	Handshoe Mouse Wired R/H Large	£90.00
9861101	Handshoe Mouse Wireless R/H Large	£108.00



OrthoMouse

The new paradigm in shape, design and use for mice. A precision tool which adapts to your hand. The OrthoMouse is the logical way to reduce discomfort and complaints related to the use of common mice (RSI).

- Great sensibility and maximum control
- The OrthoMouse allows different configurations to fit different hand sizes
- Each click requires only instant flexion and relaxation movements

9734035	Orthomouse	£89.00
---------	------------	--------

all prices exclusive of vat

Measure hand here... Less than 17.5 cm = Small Penguin. Greater than 17.5 cm = Standard Penguin



Logitech Performance Mouse MX

With the Logitech Performance Mouse MX, you'll have the power to achieve. You can track precisely on more surfaces – even glass tables (4 mm minimum thickness) – thanks to Logitech Darkfield Laser Tracking.

- Tiny Logitech Unifying receiver stays in your notebook
- Hyper-fast scrolling
- Rechargeable with a flexible micro-USB system

3597001 Logitech Performance Mouse MX £89.00



Logitech Wireless Mouse M305

The Logitech Wireless Mouse M305 offers exceptional comfort and cordless convenience with its ergonomically designed soft rubber grip and the plug-and-forget nano-receiver.

- Plug-and-forget nano-receiver
- Ideal for notebooks
- High-definition optical tracking (1000 dpi)

3572001 Logitech Wireless Mouse M305 £29.99



Logitech Pilot Optical Mouse

A straightforward and affordable optical mouse. Enjoy plug & play ease and precise optical tracking. The comfortable design feels great in either hand, and setup couldn't be easier.

- Contoured for comfort
- Instant setup with no software drivers necessary
- USB to PS/2 combo connector

351201 Pilot Logitech Optical Wheel £10.95



Logitech Wireless Trackball M570

The Logitech Wireless Trackball M570 gives you a different kind of comfort. It stays in one place and supports your hand to let you work all day with ease.

- Plug-and-forget nano-receiver
- Precise cursor control
- Integrated scroll wheel and easy-to-reach Back/Forward buttons

3574 Logitech Wireless Trackball M570 £59.99



Logitech Cordless Optical TrackMan

The Logitech Cordless Optical TrackMan is designed to give you a premium level of comfort and cordless freedom. The exceptionally comfortable ergonomic design provides unmatched palm support.

- Eight buttons – including Forward, Back and Drag-lock buttons
- Fingertip-based control enables fast, accurate cursor movements
- Patented Marble optical technology ensures smooth tracking

3573 Logitech Cordless TrackMan Optical £59.99



Logitech TrackMan Marble Mouse

The Logitech TrackMan Marble gives you superior comfort – for either hand. Ambidextrous design provides long-lasting comfort for right- and left-handed people.

- Fingertip-based control enables fast, accurate cursor movements
- Ambidextrous trackball design for right and left-handed people
- Patented Marble optical technology ensures smooth tracking

3575 Logitech Marble Mouse £29.99



Microsoft Arc Mouse

The revolutionary design of the Arc Mouse combines the comfort of a desktop mouse and the portability of a notebook mouse. Arc Mouse folds to 60% of its fully expanded size when you're on the go.

- Folds for portability
- Snap-in wireless transceiver
- Comfort for either hand

9745018 Microsoft Arc Mouse £43.08



AirO2bic Quill Mouse

The ergonomic AirO2bic Quill mouse is a popular model based on the 'Vertical' mouse design that supports your hand in a neutral, relaxed position.

- Left and right-handed models
- Wrist guard heel and side wall minimise wrist flexing

83140 AirO2bic Mouse Right Handed White £84.95

83137 AirO2bic Mouse Left Handed White £84.95

83139 AirO2bic Mouse Right Handed Black £84.95

83136 AirO2bic Mouse Left Handed Black £84.95



Hoverstop Laser Mouse

The Hoverstop helps you minimise the amount of time your hand spends on the mouse by reminding you to take your hand off the mouse when you are not actually using it, thus reducing harmful static muscle tension.

- Ambidextrous design - right and left-handed use
- High resolution 400 / 800 DPI LASER
- Built in sensor and vibration help remind you to rest your mouse hand

9702102 Hoverstop Mouse £49.99



Humanscale Switch Mouse

The Switch Mouse is an innovative mousing solution that boosts comfort and reduces the risk of injury. The V-shaped base puts the wrist and forearm into a natural pronation for left or right-handed users.

- Four-way scrolling dish provides vertical and horizontal navigation
- Adjustable length ensures proper fit for most users
- Programmable buttons for user-specified functions

83124 Humanscale Switch Mouse £62.00



Perific Wireless Dual Mouse

The high-performance Perific Wireless Dual Mouse brings you variation, comfort and flexibility in every day computer work. Use it as a traditional desk mouse, or explore the benefits of off-desk usage.

- Switch between different work postures
- Excellent tool for graphics work, gaming and presentation

5381 Perific Wireless Dual Mouse £99.00



Pen Mouse

The Pen Mouse is the ideal tool for use as an ergonomic mouse and as a laser pointer, so presentations become effortless. There is no need for a mouse mat, as it can be used on any non-reflective surface.

- Built-in rechargeable Li-ion battery
- USB Charging
- Transmission distance: up to 10 meters

9731000 Pen Mouse Presenter (With Laser Pointer) £49.95



Contour RollerMouse Pro2

The Contour Roller Mouse Pro2 is a wrist rest with an integrated central 'bar' pointing device. The bar moves left and right to move the mouse pointer left and right, and rolls to move the mouse pointer up and down.

- Eliminates reaching - relieving neck, shoulder and elbow pain
- Easy to use keyboard "lifters" elevate your keyboard to the proper height

4401100	Contour RollerMouse Pro2 Black	£179.00
4401106	Contour Roller Mouse Pro2 White	£179.00



Contour RollerMouse Free2

The RollerMouse Free2 is a revolutionary and advanced central pointing device which uses a rollerbar to control the cursor movement. The rollerbar is accurate and intuitive to use.

- Eight button/functions made for productivity and ergonomics
- Fully open rollerbar, which offers more freedom and variation

4401201	Contour Roller Mouse Free2 Black	£199.99
4401202	Contour Roller Mouse Free2 White	£199.99



Trackbar Emotion

Trackbar Emotion represents the latest in ergonomic and technological science and the most up-to-date industrial design. It was mindfully created for both preventative as well as rehabilitative use.

- Symmetric design allows the use of both hands evenly
- Equipped with 5 programmable buttons
- Large roll bar allowing for precise cursor motion with less manual effort

4501100	Trackbar Emotion	£49.95
---------	------------------	--------



Anir Wireless Mouse

Clinically proven to alleviate pain and discomfort of repetitive stress injuries in the hand, wrist, or arm. Designed as a pilot stick, the mouse encourages a natural vertical hand position with the thumb pointing upwards.

- Available in wired and wireless versions, small or large sizes

4507113	Black Anir Mouse Large Wireless	£125.15
4507114	Black Anir Mouse Small/Medium Wireless	£125.15
4507105	Black Anir Mouse Small/Medium	£79.95
4507104	Black Anir Mouse Large	£79.95



Wacom Bamboo Pen & Touch Graphics Tablet

Bamboo Pen & Touch combines the benefits of Multi-Touch with the comfort and precision of Wacom's ergonomically-designed pen. With Multi-Touch, you use simple hand gestures and finger taps to control your computer.

- 512 levels of pressure sensitivity on the pen tip for natural pen strokes
- Textured work surface for a pen-on-paper feel
- Tablet Dimensions (WxH): 249 x 175 mm

9745075	Wacom Pen & Touch Graphics Tablet	£84.99
---------	-----------------------------------	--------



Trust Slimline Design TB-6300 Graphics Tablet

This graphics tablet comes with 42 programmable shortcut buttons for greater freedom of use, and it's supplied with a wireless mouse and a stylus. You'll be able to take your graphics applications even further!

- Low profile tablet with big 200 x 150 mm working space
- Ergonomic wireless 3 button pen with 512 step pressure sensitivity
- Includes wireless 3 button scroll mouse for both left and right hand users

9745073	Trust Slimline TB-6300 Graphics Tablet	£49.99
---------	--	--------



Workstation Accessories

Document Holders • Writing Boards • Writing Slopes • Headsets

The twists and turns of everyday working life can often cause you problems. Document holders and slopes can help to avoid the worst of them. You can read and type at your workstation without twisting your neck and back and putting undue strain on your body.

Our CEO, Ian Fletcher-Price, can vouch for their effectiveness. He designed the Original Posturite Board 20 years ago as a way of overcoming his own neck pain. Along with our hugely popular MultiRite two-in-one document holder and writing slope, it's still one of our best-sellers.

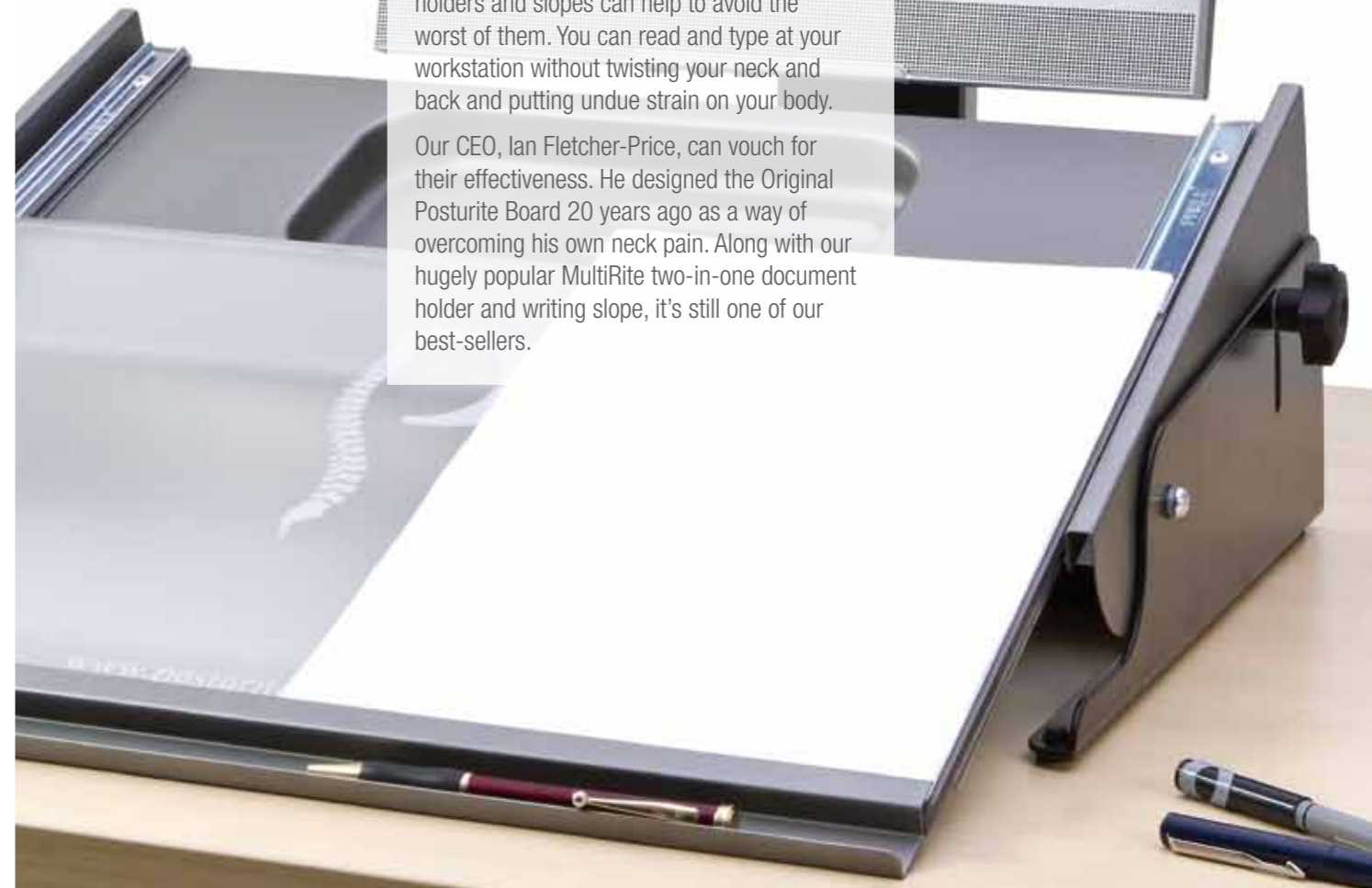



MultiRite Document Holder & Writing Slope

Our unique two-in-one document holder and writing slope that helps to reduce workaday aches and pains by allowing you to read, write or type without risking awkward twists or turns. Unique to Posturite, it's still our best-selling product – a must-have accessory for any workstation.

- Elegantly simple to adjust height and angle
- Single pivot point at the front and infinite one touch adjustment at the rear
- Storage tray
- Sliding top provides 2 different working positions
- Allows you to make optimal use of your workspace
- Rubber feet ensure stability
- Available in Mini, Standard and Large sizes:



Mini MultiRite (compact keyboards)

Designed for space-saving smaller keyboards.

- Dimensions (LxWxH): 360 x 350 x 170 mm

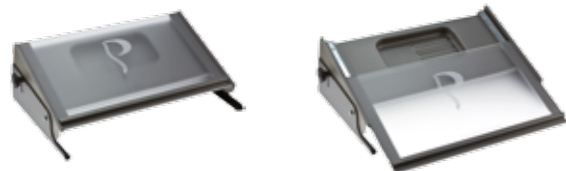

Standard MultiRite (standard keyboards)

The original version, elegantly simple to adjust both height and angle.

- Dimensions (LxWxH): 510 x 350 x 170 mm

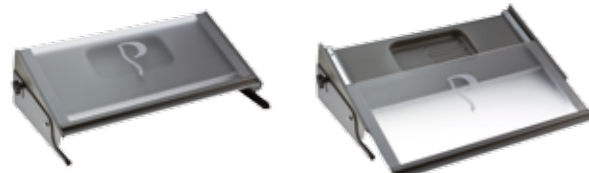

Large MultiRite (Bloomberg type keyboards)

Designed to accommodate the extra large Bloomberg keyboards and peripherals such as the RollerMouse Pro.

- Dimensions (LxWxH): 560 x 350 x 170 mm

1104M	Mini MultiRite	£94.95
1104	Standard MultiRite	£104.95
1104L	Large MultiRite	£124.95



Posturite Board

Posturite Boards prevent and relieve aches and pains including headaches, neck and back pain, shoulder fatigue and eye strain, thereby improving work efficiency. Available in a large and mini version.

The unique magnetic facility enables the user to hold papers at the optimal position for correct posture.

- Rubber feet ensure stability
- Choice of angles ranging from 18 to 35°
- Large Board Dimensions (LxW): 575 x 445 mm
- Mini Board Dimensions (LxW): 380 x 400 mm

Additional Add-ons



Book Holder

Book Ledger

Keyboard Holder

Keyboard Holder

The Keyboard Holder attachment is for use with Posturite Boards and is designed specifically for wheelchair users and the visually impaired. The Keyboard Holder attaches all standard keyboards to Posturite Boards for ease of typing and to save space.

Dual Purpose Book Holder

Sits anywhere along the top edge of the board to support books and such at eye level. It incorporates a small ledge to store pens.

Book Ledger

Hooks onto the board providing a half inch lip to support heavier books or files. This ledger can be positioned anywhere and can also create a larger work surface with a partial overhang when required.

1011	Posturite Mini Sloping Writing Board	£94.95
1001	Posturite Sloping Writing Board	£104.95
1021	Posturite Book Holder	£34.95
1031	Posturite Book Ledger	£32.95
1041	Posturite Keyboard Holder	£37.95
1091	Additional Magnet for Posturite Board	£4.95
1092	Paper for Writing Board	£1.45



Posturite WriteAngle

Acrylic, portable fixed height writing slope with optional reference folder.

- Available in: Black, Green, Royal, Purple, Red, Orange and Aqua
- 2 sizes available: standard and extra wide
- Standard Dimensions (LxWxH): 400 x 345 x 100 mm
- Extra Wide Dimensions (LxWxH): 400 x 420 x 100 mm

1051	Posturite WriteAngle - Satin Finish	£29.95
1051*	Posturite Coloured WriteAngle (Select colour)	£32.95
1052	Posturite WriteAngle - Extra Wide	£32.95
1053	WriteAngle Reference Holder	£19.95



Junior Coloured Posturite Angle

Indestructible acrylic slopes, designed to withstand the demands of the user age group!

- Ideal for children to use in school, at home for homework or colouring
- Designed to help avoid unnecessary strain on developing spines
- Dimensions (LxWxH): 400 x 355 x 114 mm

1075	Junior Slopes Red	£32.95
1076	Junior Slopes Yellow	£32.95
1077	Junior Slopes Blue	£32.95
1078	Junior Slopes Green	£32.95



Posturite Document Slope

Acrylic, cost-effective and practical document holder available with an optional wrist rest.

- Available in: Green, Royal, Purple, Red, Orange and Aqua
- Perfect for typing from large books or papers
- Dimensions (LxWxH): 560 x 290 x 120 (back) / 70 (front) mm

1058CLE	Posturite Coloured Document Slope Clear	£34.95
1058*	Posturite Document Slope - Select colour - 6 available	£34.95

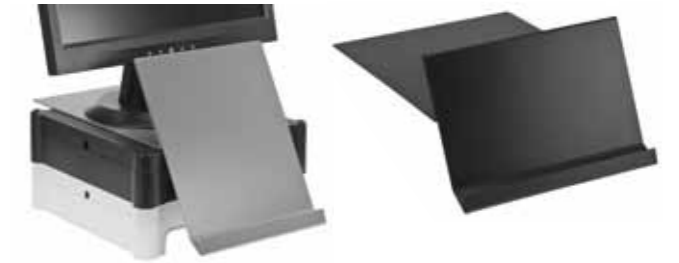

Posturite Ergoview

Provides an angled ledge to support A4 portrait or landscape documents.

- Places the document between the keyboard and the monitor and prevents any additional head movement
- Available in portrait or landscape

1511	Portrait Ergoview Doc Holder - Grey	£18.95
1512	Landscape Ergoview Doc Holder - Grey	£19.95
1511BL	Portrait Ergoview Doc Holder - Black	£18.95
1512BL	Landscape Ergoview Doc Holder - Black	£19.95



Euro Copyholder

Position the Euro Copyholder between the screen and keyboard and simply fold away under the monitor when not in use.

- Base dimensions (LxW): 420 x 390 mm
- Extra wide lip for large piles of paper or big books (optional extra)
- Adjustable side extension (optional extra)

1401104	Euro Copy Holder	£49.95
1401106	Extension Feet (pair) for Copy Holder	£29.95
1401107	Extra Large Lip for Euro Copy Holder	£9.95
1401108	Extension Plate for Large Copy Holder	£19.95



IR Document Holder

Simple cost effective and practical document holder.

- Standard Dimensions (LxWxH): 510 x 280 x 125 mm
- Large Dimensions (LxWxH): 510 x 280 x 180 mm
- Sturdy Dimensions (LxWxH): 550 x 305 mm

	Grey		Black	
Standard	1070	£32.95	1070BL	£32.95
Large	1056	£34.95	1056BL	£34.95
Sturdy	1071	£36.95	1071BL	£36.95



Clean-doc 440

In-line document holder that attaches to existing monitor arm. Combines document holder and storage tray for 'clean desk' approach. Creates extra workspace with holder in storage position.

- Suitable for 14 to 24 inch monitors
- Includes pen tray
- Dimensions (LxWxH): 50 x 430 x 304 mm

4507117 CleanDoc 440 **£99.95**



Q-Doc 400 Document Holder

Aluminium design document holder. Place the Q-Doc between your screen and keyboard to create an in-line workstation that prevents undue head and neck movements.

- Document holder with different angles: 6 positions
- Lightweight (480 g), completely foldable
- Dimensions (LxWxH): 370 x 280 x 27 mm (folded)

4507103 Q-Doc 400 **£74.95**



Q-Doc 415 Document Holder

This adjustable document holder creates a comfortable in-line workstation. The document holder is placed between screen and keyboard, creating an in-line workstation that prevents undue head and neck movements.

- Height adjustability (7 positions from 12° to 46°)
- The Q-doc allows compact keyboards to be stored
- Dimensions (LxWxH): 390 x 275 x 115 mm

1082 Q-Doc 415 Document Holder **£69.95**



U Slope Pro Document Holder

The U Slope Pro is an A3 document holder and reading/writing slope. It is also designed to be used with laptop stands and large monitor blocks as well as monitor arms.

- 13 angles from 8° to 55°
- Built-in book holder
- Extra high version available for specialist keyboards

9811011 U Slope Pro **£99.00**



U Copy Document Holder

An angle adjustable A3 copy holder which can be well placed between the keyboard and monitor to help reduce awkward neck and eye movements, thus promoting better health. Supplied with a strong magnet.

- Magnetic line guide, book holder and file shelf available (accessory pack)
- 15 angles from 18° to 43°

9811001 U Copy **£49.99**

9811002 U Copy Accessory Pack **£29.99**



U Turn Document & Book Holder

This clever little but sturdy stand offers 7 levels of adjustment for A4 landscape or portrait document and book support. The Unique design allows the user to choose easily and quickly between a document holder and a book holder.

- 7 angles from 25° to 65°
- Non-slip magnetic support arm

9811010 U Turn **£24.99**



3M Document Holder

By keeping documents positioned as close to your monitor as possible, document holders help to reduce eye, neck and shoulder movement. This document holder helps to minimise strain and enhances overall comfort.

- Mounts on either side of most flat screens
- Adhesive strip for easy set up
- Folds away when not in use

1560 3M Flat Screen Document Holder **£36.06**



Posturite Freestander Document Holder

Designed specifically for large heavy books, the Freestander raises the copy to eye level next to the monitor and is suitable where clamp fit document holders cannot be used.

- Shelf can be adjusted over 4 height ranges 100-200 mm from the desk
- Weight: 3.94 kg
- Dimensions (LxWxH): 260 x 200 x 370 mm

1501 Posturite Freestander Document Holder **£44.95**



Posturite Ultimate Freestander Document Holder

Designed specifically for copy-typing large bundles of papers, the Ultimate Freestander raises the copy to eye level next to the monitor.

- Comes complete with an adjustable line guide for easy reference
- Height adjustable from 144-345 mm
- Weight: 3.48kg
- Dimensions (LxWxH): 280 x 230 x 430 mm

1502 Posturite Ultimate Freestander **£54.95**



Vuryte Document Holder

Adjustable document holder that allows vertically aligned positioning of copy data directly beneath the display screen.

- Adjustable angle for maximum comfort and productivity
- Horizontal slide action ensures access to storage shelves and monitor
- Available in 14" and 18"

1578 Vuryte Document Holder - 14 inch **£59.95**

1579 Vuryte Document Holder - 18 inch **£62.95**



Plantronics Voyager 510 Headset, Base & Lifter

The versatile Voyager 510 Bluetooth headset with WindSmart technology delivers all day wearing comfort and superior audio quality in a stylish and discreet design.

- A single headset for both mobile and office phone
- Headset, charging base and lifter (optional)

702505 Voyager 510 Headset and Base Only **£178.50**

702504 Voyager 510 Headset, Base & HL10 Lifter **£204.80**



Plantronics CS60 USB Headset

The CS60-USB is a totally wireless and stylish DECT headset system giving excellent sound quality and hands-free headset convenience for most VoIP softphone telephony applications.

- USB connection to PC
- Excellent sound quality
- Freedom to move 50 metres range

7032 CS60 USB Headset **£199.00**



Plantronics CS60 Headset

This general purpose wireless headset with a choice of wearing styles is cost-effective, offers excellent sound quality and lets you roam up to 100 metres from your desk without missing a call.

- All-day comfort - free both hands whilst on the phone
- Choice of three wearing styles – headband, over-the-ear or optional neckband

7025	CS60 Cordless Headset & HL10 Lifter	£209.00
------	-------------------------------------	---------



Plantronics CS351N SupraPlus Headset & Lifter

SupraPlus Wireless lets you use your phone away from your desk, offering all day wearing comfort. Both monaural and binaural versions have a noise-cancelling microphone.

- Up to 100-metres range (50 metres in typical office)
- Up to 9 hours talk-time, up to 50 hours on standby time
- Compatible with most popular business telephones

7100	Supra Plus Monaural Wireless & HL10	£231.00
------	-------------------------------------	---------



Plantronics CS70N Wireless Headset

The stylish CS70N lets you use your phone whilst away from your desk, but is so discreet and comfortable you may forget you are wearing it.

- A more efficient way for busy executives and managers to multi-task
- Up to 100-metres range (50 metres in typical office)
- Excellent sound quality combined with a noise cancelling microphone
- Up to 6 hours of continuous talk time on a single charge

7102	CS70 Wireless Headset & HL10 Lifter	£209.00
------	-------------------------------------	---------



Plantronics SupraPlus Headset

Setting new standards in style and performance, SupraPlus has wideband audio response. Its lightweight design makes it comfortable for the most demanding of environments.

- Genuine productivity tool – hands free phone calls for easier multi-tasking
- Monaural or binaural – make your choice dependant on your preferences
- Noise-cancelling or removable voice-tube (shown)

7055	Supra Plus Wideband Monaural Headset	£73.40
------	--------------------------------------	--------



Plantronics DuoPro Headset

Configurable for every user, the Plantronics DuoPro headset is the ultimate in versatility.

- Superior comfort in both over-the-head and over-the-ear configurations
- Innovative design effectively positions speaker pad gently next to the ear
- Cord guide for greater ease of use and lightweight comfort
- Choice of voice tube (shown) or noise-cancelling microphones

7053	DuoPro Headset	£87.80
------	----------------	--------



U10P Cable/M12 Vista Amplifier

U10P Cable

Recommended for use with every wired office headset. The U10P cable is necessary to plug the headset into.

M12 Amplifier

The M12 is simple to install, compatible with virtually any telephone system and can be used with the full range of Plantronics headsets.

7065	U10P Polaris Cable	£11.20
------	--------------------	--------

7048	Vista M12 Amplifier	£104.20
------	---------------------	---------



Monitor Solutions

Monitor Arms • Monitor Raisers • Screen Filters • CPU Holders

Having your computer monitor at the wrong height is a common cause of neck and shoulder pain. Ideally the screen should sit directly in front of you at arm's length, with the top level with your eyes.

Monitor arms offer the most ergonomically efficient way to ensure your screen is always at the correct height and angle for you. They also have the added advantage of freeing up valuable desktop space. Stackable posture blocks are less flexible in terms of their adjustability, but a lot more economical.



FLO Monitor Arm Solution

Flo works in unison with the adjustable spring to set the optimum tension to the screen weight and deliver perfect usability. Engineered to tread lightly on the environment... and offer maximum performance with the minimum number of parts, Flo offers an unrivalled level of design purity.

Complete package straight out of the box with choice of clamp or grommet fixing.

- Ergonomically compatible with touch-screens
- Maximum monitor weight: 9 kg
- Reach: 515 mm

1820200	FLO Monitor Arm with Clamp Fixing	£135.00
1820201	FLO Monitor Arm with Through Desk Fixing	£135.00



Wishbone Monitor Arm Solution

Wishbone is a true system arm available in three reach lengths which make it the ideal choice for multi-screen applications such as trading floors and control rooms. Wishbone can be installed at different heights to suit different environments.

- Maximum monitor weight: 12 kg
- Reach: 425 mm

1820004	Wishbone Arm Quick Release Silver	£121.00
1822022	Wishbone Arm, 400mm Post, 38mm Desk Clamp	£176.00
1822059	Wishbone B2B Arm, 400mm Post, 38mm Clamp	£337.00



Giselle Gas Lift Arm Solution

Giselle is an elegant post-mounted arm that combines strength with ease of movement. Thanks to an internal gas strut, Giselle gives users fingertip control over monitors that weigh up to 8.5 kg (18.7lb). It is therefore the ideal choice for workspaces occupied by different users such as hot desks and call centres. For slatwall mounting, Giselle X can be used, as its horizontal forearm sets a base for screen height.

- Maximum monitor weight: 8.5 kg
- Reach: 520 mm

1820060	Giselle Gas Lift Arm Silver	£135.00
1822046	Giselle arm, 200mm post, integral clamp	£161.00
1820078	Giselle X Gas Lift Arm	£135.00



Zorro Monitor Arm Solution

A simple, yet innovative aluminium flat screen monitor arm. Zorro combines function with beautiful design. Its diagonal profile means that Zorro can be mounted on shorter posts to give cleaner lines in the workspace. The innovative ball joint gives the user full control over the screen angle to increase comfort and reduce glare.

- Fits all VESA compliant flat screen monitors
- Maximum monitor weight: 8.5 kg
- Reach: 460 mm

1820025	Zorro Arm Quick Release Silver	£116.00
1822021	Zorro Arm, 300mm Post & 38mm Desk Clamp	£168.00



Rodney Monitor Arm Solution

Rodney is designed to be used by the full range of users, or more precisely their divergent shapes, heights and sizes. Rodney has been simplified so that there is no need for a separate arm and post, instead the two components have been designed into one single piece. With desk clamp included, integrated cable management and security features as standard, the product is ready to install and use immediately with no add-ons required.

- Available in 3 colours: Silver / White / Black
- Maximum monitor weight: 8.5 kg
- Reach: 492 mm
- Max Height: 470 mm

1822100	Rodney Monitor Arm, Post & Clamp	£89.00
---------	----------------------------------	--------



Daisyone Monitor Arm Solution

Daisyone (Daisy) embodies perfection in geometrical design. The precision engineered Daisy screen position allows for two screens to be mounted at the same height on a single post, without the need for a separate back-to-back bracket. Used on the quad post, Daisy also offers a 180 degree stop function, preventing potential damage to privacy screens.

- 160° vertical tilt
- 180° horizontal movement
- Maximum monitor weight: 8.5 kg
- Reach: 505 mm

1823002	Daisyone Arm, 500mm Quad Post & Clamp	£170.00
1823003	Daisyone B2B Arms QR, 500mm Post & Clamp	£267.00

Monitor Arm Solutions

These workstation solutions provide the ultimate flexibility with a modular system of components that when combined create a versatile workstation and free up valuable desktop space.

Every situation is unique, if the packages on these two pages do not fit your requirements, you can choose your own bespoke monitor solution.

Choose your desired Monitor Arm and then choose a post and fixing option from below.

Post Options

Choose the height of post that best suits your requirements.

- Extension studs and other sized posts available

1822016	200mm Post Silver	£26.00
1820057	300mm Post Silver	£33.00
1820010	400mm Post Silver	£36.00
1820058	500mm Post Silver	£40.00
1820065	700mm Post Silver	£58.00

Desk Mount Options

- Desk Clamp: up to 38 mm in desk thickness
Large version: up to 67 mm
- Through Desk: Up to 35 mm in desk thickness
- Grommet Fixing: For 76 mm diameter cable hole (38 mm desk thickness)



1820001	Desk Clamp Fixing up to 38mm	£19.00
1820017	Desk Clamp Large 67mm	£39.00
1820011	Through Desk Fixing up to 35mm	£8.00
1820042	Cast Grommet up to 38mm desk thickness	£38.00

Screen & Alternative Mounted Options

- Toolbar Bracket: Allows horizontal movement of monitors
- Slat Wall Bracket: Suitable for slat wall and wall mounting
- Back-to-Back Fixing: For mounting two monitors back-to-back



1820088	Wishbone Toolbar Bracket	£38.00
1820008	Slat Wall Fixing Bracket Silver	£34.00
1820009	Wishbone Back to Back Bracket	£40.00



Albert Mobile Workstation

A monitor support systems designed to facilitate stand alone, multi-function environments for example healthcare, libraries, educational centres etc.

- Phone for details on bespoke versions

1822002	Albert Mobile Workstation - Palm	£717.40
---------	----------------------------------	---------



Screen Mate

A sturdy, multifunctional mounting arm for flat screen monitors. Combines a modern design with many ergonomic advantages.

- Expandable up to four monitors with modular mounting system
- Available with a clamp fitting or with a through desk fitting

3809100	Screen Mate (Monitor Arm with Clamp Fit)	£89.00
3809101	Screen Mate (Monitor Arm & Through Fit)	£89.00



Jetmaster Monitor Arm

The combination of Jetmaster arms and LCD monitors can be moved infinitely - forwards and backwards, higher and lower to the left or right, through 90° to upright.

- Load capacity 5 kg
- Available in 2 or 1 link options

3023	Jetmaster 1 Link Light Grey With Clamp	£135.00
3026	Jetmaster 2 Link Light Grey	£160.00
3023BL	Jetmaster 1 Link Anthracite	£135.00
3026BL	Jet Master 2 Link Anthracite	£160.00



Ergotron LX Desk Mount LCD Arm

Sleek and streamlined, the LX frees up space and allows positioning of your display for greater productivity. Reposition your LCD with just a touch. Up, down, forward and back. The LX provides unparalleled range of motion.

- Polished aluminium offers greater durability and enhanced aesthetics
- Snap-fit cap secures interface of arm to extension for greater stability

9780004	Ergotron LX Desk Mounted Arm Silver	£128.00
---------	-------------------------------------	---------



Ergotron Neo-Flex LCD Desk Stand

Easily upgrade your existing monitor stand for the fully adjustable Neo-Flex LCD stand. Instantly set the height of your LCD for a more comfortable computing experience.

- Upgrade monitors or TVs with improved ergonomic adjustability
- Five vertical adjustment options
- Sleek, durable, easy-to-clean plastic exterior

9780003	Ergotron Neo-Flex LCD Stand Black/Silver	£37.00
---------	--	--------



Screen Height Adjuster (Retro Fit)

This simple attachable plate can be easily retro-fitted to most screens giving the user the flexibility to adjust the screen to a more suitable and comfortable working level. Rear of screen should have a level surface.

- 150 mm range of height adjustments / 10 mm height step increments
- Quick and easy to attach
- Fits either 100 or 75 mm VESA plates

9820004	Screen Height Riser - Retro Fit	£29.99
---------	---------------------------------	--------



Flat Screen Posture Blocks

Stackable posture blocks offer maximum monitor height adjustability and locking stability at minimum cost.

- Dimensions (LxWxH): 310 x 230 x 65 mm
- Each block is sold separately

6103	Posture Blocks for Flat Screens Grey	£12.95
6104	Posture Blocks for Flat Screens Black	£12.95
6104SIL	Posture Blocks for Flat Screens Silver	£13.95



Posture Blocks

Stackable monitor blocks for CRT monitors.

- Available in 1 or 2 inch height
- Dimensions (LxW): 295 x 295 mm
- Each block is sold separately

	1 Inch Posture Blocks		2 inch Posture Blocks	
Grey	6099	£5.95	6100	£10.95
Black	6105	£5.95	6106	£10.95
Silver	6105SIL	£6.95	6106SIL	£11.95



Vuryser Blocks - Extra Large

Stackable posture blocks offer maximum monitor height adjustability and locking stability at minimum cost.

- Ideal for large monitors
- Dimensions (LxWxH): 420 x 385 x 50 mm
- Max capacity: 65 kg
- Each block is sold separately

6102	Vuryser Block Extra Large - Black	£19.95
------	-----------------------------------	--------



Adjustable Anti-Glare Screen Hood

Reduce glare from overhead lighting and sunlight reflection.

- Simple to install with double sided Velcro fastening
- Flat screen hood fits 15.9-26.8 inch monitors
- CRT hood fits 12.8-20 inch monitors

3173	Adjustable Hood for Flat Screen	£29.95
3171	Anti-Glare Screen Hood for CRT Monitor	£24.95



LCD Privacy Screen Filter

Privacy feature ensures that when viewed from the front the image is perfectly clear but when viewed from either side the image is blurred. Protects the LCD surface from damage.

- Enhances visual performance

9725001	15" LCD Privacy Acrylic Screen Filter	£89.00
9725002	17" LCD Privacy Acrylic Screen Filter	£99.00
9725008	19" LCD Privacy Acrylic Screen Filter	£134.95

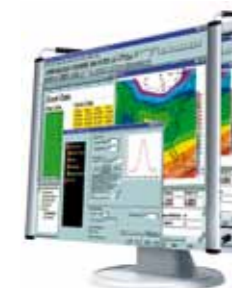

LCD Magnifier

Computer screen magnifier for your LCD desktop displays. When you need enhanced screen visibility for your LCD monitors, this elegant, lightweight model provides magnification clarity.

- Magnifies screen
- Available in 15, 17, and 19 inch

9725003	15" LCD Screen Magnifier	£89.00
9725004	17" LCD Screen Magnifier	£99.00
9725009	19" LCD Screen Magnifier	£139.00



Jaw CPU Cradle

Jaw is a simple and elegant CPU holder that enhances the look of any workspace design. The clamping function of the aluminium body grips tightly to the top and bottom of the CPU to secure it in place.

- Allows CPU to float below the desk
- Innovative gravity release mechanism
- Available with either rotate or slide & rotate (shown) mechanism
- Max weight: 25 kg
- Min CPU (WxH): 90 x 290 mm
- Max CPU (WxH): 240 x 510 mm

1820037	Jaw Adjustable CPU	£81.00
1822024	Universal Mounting Bracket & Rot Func.	£14.00
1820053	Universal Slide & Rotate Kit 350mm	£16.00



Clam CPU Cradle

Clam is a strong and secure solution for CPUs of any size. Clam's reinforced aluminium frame envelopes the CPU.

- Fixing bracket optional (shown)
- Weight capacity: 25 kg

Clam 01:

Min CPU (WxH): 90 x 250 mm / Max CPU (WxH): 140 x 460 mm

Clam 02:

Min CPU (WxH): 140 x 300 mm / Max CPU (WxH): 240 x 560 mm

1822008	Small Adjustable CPU Cradle (Clam01)	£92.00
1822012	Large Adjustable CPU Cradle (Clam02)	£99.00
1822024	Universal Mounting Bracket & Rot Func.	£14.00
1820053	Universal Slide & Rotate Kit 350mm	£16.00



Adjustable CPU Cradle

Adjustable CPU stand with static adjustable width and height mounting bracket. The adjustable cradle accepts most CPU's. Manufactured in epoxy polyester-coated tubular steel. Also available with slide out rotation facility.

- Fix position of CPU under desk
- Optional slide and rotate mechanism (shown)
- Adjustable support platform to accommodate different CPU sizes
- Max weight: 25 kg
- Min CPU (WxH): 110 x 350 mm
- Max CPU (WxH): 260 x 560 mm

1820059	Adjustable CPU Cradle	£41.40
1822024	Universal Mounting Bracket & Rot Func.	£14.00
1820053	Universal Slide & Rotate Kit 350mm	£16.00



Mobile CPU Basket

Adjustable mobile CPU trolley on robust castors. Manufactured in epoxy polyester coated tubular steel.

- Mobile adjustable CPU cradle
- Includes four castors for optimum mobility
- Free desk space
- Max weight: 25 kg
- Min size CPU width: 105 mm
- Max size CPU width: 210 mm

1820051	Mobile CPU Basket	£43.00
---------	-------------------	--------

Laptop Solutions

Laptop Sets • Laptop Stands • Bags • iPad & Tablet

Our rapidly-growing use of laptop, notebook and tablet computers is fast turning us into a nation of 'slouch' potatoes. The hunched position most users adopt when sitting at their laptops has led to an increase in neck, back and shoulder problems, particularly among the young.

Our ergonomic laptop solutions will help take the 'ouch' out of laptop slouch. Using a separate ergonomic keyboard and mouse; a laptop stand to raise the screen to eye level; a stable base on which to work; taking regular breaks to relieve upper body tension; and a special backpack to carry the laptop around will all help to protect against musculoskeletal problems.

Laptop Sets

Complete laptop solutions.

A portable laptop stand, used in conjunction with a separate ergonomic keyboard and mouse, will improve your posture by ensuring that your screen is at the correct height and you are able to maintain a comfortable position while typing and using your mouse.

Save money as well as your body by taking advantage of any of the bargain bundles on this page.

	Ergo-Q 330	Posturite	Cricket
Number Slide Keyboard + Penguin Vertical Mouse	1111001 £149.95	1111013 £134.95	1111025 £129.95
Number Slide Keyboard + Microsoft Arc Mouse	1111002 £144.95	1111014 £129.95	1111026 £127.95
Number Slide Keyboard + Logitech Pilot Mouse	1111003 £114.95	1111015 £99.95	1111027 £98.95
Compact Mini Keyboard + Penguin Vertical Mouse	1111004 £119.95	1111016 £109.95	1111028 £104.95
Compact Mini Keyboard + Microsoft Arc Mouse	1111005 £114.95	1111017 £99.95	1111029 £99.95
Compact Mini Keyboard + Logitech Pilot Mouse	1111006 £87.95	1111018 £74.95	1111030 £69.95
Microsoft Arc Keyboard + Penguin Vertical Mouse	1111007 £147.95	1111019 £129.95	1111031 £129.95
Microsoft Arc Keyboard + Microsoft Arc Mouse	1111008 £139.95	1111020 £128.95	1111032 £124.95
Microsoft Arc Keyboard + Logitech Pilot Mouse	1111009 £109.95	1111021 £98.95	1111033 £94.95
Ergostars Saturnus Keyboard + Penguin Vertical Mouse	1111010 £149.95	1111022 £134.95	1111034 £129.95
Ergostars Saturnus Keyboard + Microsoft Arc Mouse	1111011 £144.95	1111023 £129.95	1111035 £127.95
Ergostars Saturnus Keyboard + Logitech Pilot Mouse	1111012 £114.95	1111024 £99.95	1111036 £98.95

Step 1. Choose a Laptop Stand



Ergo-Q 330 Laptop Stand

Posturite Portable Laptop Stand



Cricket Laptop Stand

Step 2. Choose a Keyboard



Number Slide Arch Keyboard

Ergostars Saturnus Keyboard



Microsoft Arc Wireless Keyboard

Compact Mini Keyboard

Step 3. Choose a Mouse



Logitech Pilot Mouse

Microsoft Wireless Arc Mouse



Penguin Vertical Mouse - Large Wired (can be substituted for standard size)

For full spec of these products, please see Input Devices.



Ergo-Q 260 Laptop Stand

Portable, aluminium, award winning design notebook stand. Including pivotable patented in-line document holder.

- Weight: 390 g
- Dimensions folded (LxWxH): 310 x 230 x 7 mm
- High quality hylite aluminium, rubber anti-slip feet
- Height range: 90-210 mm (5 height settings)

4507102 Ergo Q260 £95.95



Ergo-Q 330 Laptop Stand

Portable notebook stand with built-in document holder, pivotable for easy laptop set-up.

- Weight: 485 g
- Dimensions folded (LxWxH): 310 x 228 x 13 mm
- ABS, rubber anti-slip feet
- Angle adjustment range: 20° to 40° (6 angles)

4505101 Ergo-Q 330 £63.95



Posturite Portable Laptop Stand

Lightweight portable laptop stand places the screen in the visual attention area, taking strain away from your shoulders, neck and eyes.

- Weight: 850 g
- Dimensions folded (LxWxH): 240 x 280 x 15 mm
- Powder-coated mild steel
- Height range: 110-215 mm

1064 Posturite Portable Lap Top Stand £49.95



Slim Cool Laptop Stand

Telescopic side bars provide a wide support and also help to keep the laptop cool as they allow for increased airflow.

- Weight: 550 g
- Dimensions folded (LxWxH): 182-275 x 252 x 10 mm
- Lightweight aluminium complete with carry case
- Height range: 6 levels of adjustment

1401110 Slim Cool Laptop Stand £49.95



CBS Lapjack Laptop Stand

Lapjack is a portable, aluminium, ergonomic support for laptop computers, incorporating copy holder and cable management.

- Weight: 380 g
- Dimensions folded (LxWxH): 296 x 236 x 10.5 mm
- Lightweight aluminium
- Height range: 175-260 mm

1820054 Lapjack £56.00



U Top Laptop Stand

Built from lightweight aluminium yet has the strength to hold 5 kg laptops. The U Top has the portability and adjustment to suit most laptops.

- Weight: 250 g
- Dimensions folded (LxWxH): 300 x 250 x 3 mm
- Lightweight aluminium
- Height range: 6 levels of adjustment

9701010 U Top Laptop Stand £44.95



Cricket Laptop Stand

The Cricket Laptop Stand elevates the screen for cool computing and comfortable viewing. Cricket props up your laptop or tablet PC, allowing you to adjust screen height as desired.

- Weight: 177 g
- Dimensions folded (LxWxH): 203 x 51 x 25 mm
- Angle adjustment range: 11 to 60° (6 increments)

9767002 Cricket Laptop Stand £45.99



Smart Shell Laptop Stand and Case

Adjustable laptop stand and combined case. When you're finished working this innovative multipurpose product forms a protective shell around your valuable portable computer during transit.

- Easy and quick access to laptop
- Fits 14.1-15.4 inch laptops
- Angle adjustment range: 20 to 43°

9811020 Smart Shell £65.00



Smart Sleeve Laptop Stand and Case

The Smart Sleeve features padded and rigid sections designed to protect the user as a comfortable ergonomic solution whilst operating a laptop. Forms a protective sleeve around your valuable portable computer during transit.

- Easy and quick access to the portable computer via a secure zip
- Fits 14.1-15.4 inch laptops
- Angle adjustment range: 20 to 43°

9811030 Smart Sleeve £89.00



Deluxe Trolley Backpack

Can't decide between a backpack or a roller case? Use this as a backpack, then fold the shoulder straps away and it instantly becomes a roller case.

- Fits laptops up to 290 x 380 mm (15 inch laptops)
- Telescopic handle - max height: 940 mm
- Padded shoulder straps
- Front pocket and removable CD wallet

4700103 Deluxe Trolley Backpack £69.95



Posturite Executive Laptop Trolley Case

Very stylish laptop trolley case with many integral compartments including an ingenious clothing section.

- Fits laptops up to 390 x 280 mm (17 inch laptops)
- Handle Height extension to 101 cm
- Numerous integral compartments including a waterproof umbrella pocket
- Dimensions (LxWxH): 400 x 350 x 260 mm

4700109 Posturite Executive Laptop Trolley Case £99.95



Slim Backpack for notebooks

Compartments for everything from pens, business cards, credit cards, power supplies, and your other notebook accessories. Separate removable pouch for your power supply.

- Fits laptops up to 405 x 315 x 35 mm (17 inch laptops)
- Made of durable polyester/nylon
- Plush inner lining protects laptops from scratches

9745078 Belkin Slim Notebook Case £28.99



Ergo-T 340 Laptop Stand

Unique, universal laptop stand that can accommodate laptops and docking stations with the Port Replicator Module PRM340.

- Ideal for office use, 'hot desking' and home offices
- Height range: 80-260 mm
- Sturdy, secure fit for all laptops up to 17 inch

4505102 Ergo-T 340 £111.90

4505103 Port Replicator Module PRM340 £24.99



Ergo Station II with 4 Port USB Hub & Fan

Ergo Station is fitted with an integrated 4 port USB 2.0 hub to support your keyboard, mouse, or just about any other peripheral. This work station also features an ultra quiet fan to prevent your laptop from overheating.

- 4 positive angle settings
- Universal design for up to 17 inch laptops
- Dimensions (LxWxD): 300 x 280 x 217 mm

9709100 Ergo Station With Fan £59.99



Posturite Lap Pack

Alter your working environment to ensure correct ergonomics when using your laptop. The Lap Pack allows you to convert a poor working position to an altogether more acceptable workstation.

The Lap Pack consists of:

- 1 x 1 inch Posture Block, 2 x 2 inch Posture Blocks, Posturite wrist support, Posturite mouse rest, keyboard & mouse, 1 USB cable adaptor

1060USB Posturite Lap Pack USB £69.95



Easy Laptop Desk

An ideal companion for your laptop in a variety of different ways. Especially useful when working with a laptop whilst in bed. Helps maintain a more comfortable screen angle and height.

- Folds flat after use - lightweight yet strong aluminium frame
- Dimensions (LxWxD): 560 x 300 x 40 mm
- Variable viewing angle and position options

9820001 Easy Laptop Desk £79.95



Ergo-Top 320

Height adjustable office notebook stand with built-in document holder and cable holder.

- Home office use and 'hot desking'
- Positions laptop screen at correct viewing level
- Secures Ergo-Top and connected peripherals with one cable lock
- Dimensions (LxWxD): 370 x 245 x 157-220 mm

1100 Ergo-Top 320 £55.95



Posturite Lap Desk

This portable worksurface is ideal for taking notes at seminars, use in a classroom and for positioning laptops whilst travelling.

- Ideal for use with laptop computer
- Generous filling of foam pellets for maximum comfort
- Available in black
- Dimensions(LxW): 420 x 380 mm

1061 Posturite Lap Desk £29.99



iPad and Tablet Solutions

If you're one of the growing number of people who use their iPad as a part-time working tool replacement for their laptop, your body will thank you for also investing in a separate ergonomic Bluetooth keyboard and a dedicated stand. They will not only help with your posture, but also improve your workflow.

NEW!

Available Summer 2011



iPad Mount for Flo Monitor Arm

For use with the Apple iPad. Features easy portrait to landscape orientation and accommodates an iPad with or without a case. The mount comes with a lock mechanism, ensuring it can be left securely on the monitor arm. Working alongside our 'dynamic' monitor arm Flo, the mount enables iPad to be freely positioned into an ergonomic position for touch screen usage.

- Add-on to Flo Monitor Arm - please see page 48

1820300	Tablet Mount for Flo Arm	£59.00
1820301	Flo Monitor Solution with Tablet Mount	£194.00



Cricket Laptop Stand

The Cricket Laptop Stand elevates the screen for cool computing and comfortable viewing. Cricket props up your laptop or tablet PC, allowing you to adjust screen height as desired.

- Weight: 177 g
- Dimensions folded (LxWxH): 203 x 51 x 25 mm
- Angle adjustment range: 11 to 60° (6 increments)

9767002	Cricket Laptop Stand	£45.99
---------	----------------------	--------



Belkin FlipBlade for iPad

Use your iPad anywhere with the stand that transforms from small and portable to safe and supportive at the push of a button. This compact stand is as minimal as it is strong. Durable material provides a firm base for your device that won't weigh down your bag or backpack.

- For use in landscape or portrait view
- Foldable and compact

9745168	Belkin Flipblade Stand	£18.99
---------	------------------------	--------



iArc iPad Stand

The perfect way to hold your iPad - when you're done holding it in your hands lets you select two different positions for storing, charging and hands-free use.

- Place iPad portrait or landscape
- Easy access to the dock connector port at all times
- Choice of viewing movies, photos and apps in widescreen

9820007	iArc Stand	£19.95
---------	------------	--------



Freedom Pro Universal Bluetooth Keyboard

Dual Profile, Bluetooth portable keyboard. Portable and practical with additional functions, improved driver software and additional keys to give you even more control of your mobile device.

- Full 5 row keyboard with 75 keys
- Uses two AAA batteries
- Compatible with a large range of mobile devices including RIM Blackberry

9767100	Freedom Pro Universal Bluetooth Keyboard	£84.99
---------	--	--------

Supports

Footrests • Wrist Rests

Sometimes the solution to preventing or improving a work-related musculoskeletal condition can be quite simple. For example, a wrist support, mouse rest or full arm support will reduce the chances of a long-term injury being caused by long periods of mouse and keyboard work.

Footrests that adjust for both angle and height will ensure that your legs and feet are properly supported and encourage a correct posture. And, as a short-term measure, lumbar rolls, seat wedges and backrests will help provide back support and promote better posture when using non-ergonomic chairs. These are also useful for car and aeroplane seats and dining room chairs.



The Master Footrest

Front or back tilting, adjustable foot stool. The Master Footrest is designed to encourage a comfortable position when working at a desk with the feet slightly raised and it lifts weight from the thighs.

- Tilt Adjustable
- Sturdy timber platform mounted on steel frame
- Dimensions (LxW): 460 x 305 mm

5701	The Master Footrest	£34.95
------	---------------------	--------



Posturite Adjustable Footrest

A simple but stable height adjustable footrest with individually height adjustable feet.

- Sturdy steel construction
- Individually height adjustable feet: 90-130 mm
- Dimensions (LxW): 455 x 295 mm

5774	Posturite Adjustable Footrest	£36.95
------	-------------------------------	--------



Footform Dual Adjustable Footrest

The Footform footrest is height adjustable up to 300 mm allowing you to raise the level of the surface to suit you. It is adjustable with a foot operated pedal making it easy to adjust throughout the working day when needed.

- Infinite height ranges up to 300 mm
- Unique, foot-operating button with integral gas cylinder
- Strong steel & aluminium frame

9877001	Footform Dual Adjustable Footrest	£119.00
---------	-----------------------------------	---------



Height Adjustable Footrest

The Height Adjustable Footrest has a foot operated height adjustment, an angle adjustable platform and is suitable for counter or bench heights of 700-850 mm.

- The contoured foot platform is designed to minimise slip
- Foot operated height adjustment
- Height adjustments of 80-290 mm

5751	Height Adjustable Footrest	£124.95
------	----------------------------	---------



Adjustable Foot Platform

This footrest is adjustable in inclination with a removable cover which reveals a compartment for the foot controls of dictating machines.

- Platform size (LxW): 450 x 350 mm
- Front height adjusts from: 40-150 mm
- Rear height adjusts from: 70-210 mm

5775	Adjustable Foot Platform	£56.00
------	--------------------------	--------



Discus Adjustable Footrest

Adjustable gas lift footrest with a central button that can be pushed with your foot to adjust the height from a seated position.

- Anti-skid modern design
- 150 - Height adjustment 50-150 mm
- 250 - Height adjustment 150-250 mm

3809103	Discus 150 Footrest	£103.00
---------	---------------------	---------

3809104	Discus 250 Footrest	£103.00
---------	---------------------	---------



HÅG Quickstep

This dynamic tilting footstool provides additional floor height and is considerably more preferable than static solutions. It further activates blood circulation and stimulates coordination.

- Tilting footrest, stimulates circulation
- Foot massager
- Balance training

5765	HAG Quickstep Footrest	£94.00
------	------------------------	--------



With Mouse Pad

Ergo Rest Armrest

This wrist and armrest clamps to your desk to offer the movement to work effectively and the support to help prevent strain and fatigue.

- Fits desk thickness 15-43 mm / Large clamp option: 34-64 mm
- Also available with height adjustability or with an integrated mouse pad

3511	Ergo Rest	£83.00
------	-----------	--------

3518	Ergo Rest & Mouse Pad - Standard Clamp	£110.00
------	--	---------

3513	Ergo Rest - Height Adjustable	£120.00
------	-------------------------------	---------



WASP Wrist Rest

The WASP (Wrist and Arm Support Platform) allows you to glide your hand across the full range of the keyboard and mouse while your wrist is comfortably supported. You won't have to support the weight of your hands and forearms whilst using your computer.

- Wrist and forearm recess
- Come as a pair

3510	WASP Wrist & Arm Support (pair)	£47.95
------	---------------------------------	--------



Mouse not included

MouseBean

This is one of those brilliant but simple ideas that you really don't know why someone didn't think of before. MouseBean was invented to tackle the problem of mouse induced wrist pain by providing support, protection and comfort. Its ergonomic design can help protect against RSI, Carpal Tunnel Syndrome and painful disabling wrist problems.

- Available in a wide range of colours and corporate branding. Please call for more information

3502	Mousebean Overprinted Posturite	£5.95
------	---------------------------------	-------



DynaSpine

Dynaspine is designed to help alleviate back ache or back pain and also to prevent symptoms of a bad back, whilst in the seated position. Dynaspine is particularly helpful if you have muscle aches, nerve pains and tension in your spine or shoulders, which are aggravated by sitting.

- Height adjustable, allows for correct fitting for all shapes and sizes
- Conforms to the contours of your spine for ideal fit
- Central vent promotes optimal airflow.

9889000	DynaSpine	£68.07
---------	-----------	--------



Portable Inflatable Lumbar Support

Inflatable lumbar support for situations where a good chair is not an option: in meetings, in a car, at home... Extremely robust rubber pump-up insert.

- Easy stretch strap with Velcro fixing
- The pump can be tucked into the strap behind the chair back
- Easily portable
- Cover can be removed for washing

9731003	Portable Adjustable Lumbar Support	£42.95
---------	------------------------------------	--------



Posturite Keyboard & Mouse Wrist Rest

This keyboard and mouse rest supports the wrist in a neutral position.

- Contoured edges for comfort
- Foam filled fabric with easy glide surface
- Available in short (for mini keyboard) and standard size

3608	Posturite Wrist Rest Short	£14.95
3607	Posturite Keyboard Wrist Rest	£16.95
3605	Posturite Logo Mouse Pads	£9.95



3M Combined Keyboard & Mouse Rest

This wrist rest is ergonomically designed to encourage correct wrist alignment during the use of a keyboard, mouse or trackball. It places the keyboard and mouse at the same level to give improved comfort and features a non-skid base for stability.

- Sleek design with tapered wrist rest & no hard edges
- Silky smooth fabric lets wrists glide easily and is non-irritating to skin

3508	3M Wrist Rest for Keyboard and Mouse	£84.37
------	--------------------------------------	--------



Relax Wrist Rest

Simply place the relax wrist rest in front of the keyboard to prevent incorrect extension of the wrist. Made from self moulding foam that shapes to your wrist and retains its shape after use.

- Available in short (mini keyboard) and standard size
- Special self-moulding slow foam allows increased blood circulation

3501	Relax Wrist Rest	£19.50
3500	Relax Wrist Rest Short	£14.95



Neutraliser Keyboard System

This Neutraliser Keyboard System can solve the problem of a lack of space at some workstations.

- Dimensions (LxW): 515 x 270 mm
- Easily adjustable for left and right-hand users
- Angle and height adjustment - no levers needed to adjust platform to correct position

3522	Neutralizer Keyboard System	£139.00
------	-----------------------------	---------



Keyboard & Mouse Rest

This Keyboard and Mouse rest attaches to your desk and provides comfortable, padded support for your wrists.

- Keyboard Rest Dimensions (LxW): 560 x 230 mm
- Mouse Rest Dimensions (LxW): 220 x 190 mm

3534	Keyboard Rest	£44.95
3533	Mouse Rest Desk Extension	£22.95



Corner Keyboard

A cost effective solution for frustrated corner desk computer users.

- Dimensions (LxW): 595 x 390 mm
- One size fits all

3556	Corner Keyboard - Metal	£29.50
3551	Corner Keyboard- Grey	£27.50

Self-Help & Posters

Posters • Lumbar Rolls & Wedges • Body Supports

Understanding the body's mechanics and the importance of sitting and lifting correctly can help avert the most common causes of back pain and work-related upper limb disorders.

We have a comprehensive library of educational and information material – manuals, posters and videos – to help people understand how they can improve their own chances of avoiding health problems in the workplace.





BackCare X-ray Posters

Set of 6 A3 Posters promoting the importance of good back care. Each poster presents an x-ray image of your posture in relevance to situations you find yourself in every day; be that, at work, at home or in your car.

- Comes as a set of 6 different posters
- Size: A3
- Printed black and blue on heavy weight paper

9753006	Set of Posture Poster (Set of 6)	£19.95
---------	----------------------------------	--------



Office Ergonomics Posters

Set of 6 A2 Posters promoting the importance of ergonomics in the office place. Each poster presents a new set of guidelines on a separate topic from 'How to sit correctly' to 'The ideal workstation'.

- Comes as a set of 6 different posters
- Size: A2

32900L	Office Ergonomics Posters (Set of 6)	£24.95
--------	--------------------------------------	--------



Art of Sitting Poster

An A2 sized poster showing key points on how to sit correctly.

- Size: A2

9003	Art of Sitting Posters A2	£0.95
------	---------------------------	-------



Manual Handling Posters

Set of 4 A2 Posters promoting the importance of manual handling. Each poster presents manual handling guidance around the workplace.

- Comes as a set of 4 different posters
- Size: A2

33000L	Lifting Techniques Posters (Set of 4)	£14.95
--------	---------------------------------------	--------



X-ray Mouse Mat

Virtually indestructible under normal use and maintaining their top quality appearance over time, these mouse mats are specially developed for optical mice as well as conventional mice, offering 100% perfect tracking.

- Non-reflective surface
- Non-slip backing

9007	X Ray Mouse Mat	£6.95
------	-----------------	-------



Posturite Lumbar Rolls

Posturite Rolls

Lumbar rolls are usually of most benefit to those users who have a particularly pronounced lordosis and require a little extra support to fit snugly.

- Circular roll available in 4 inch only
- D-shape roll available in 4 and 5 inch

The Winged Roll

This Winged Roll provides enough lumbar support to maintain the inward curve of the lumbar spine with the added advantage of lateral wings to keep the support in place.

- Height adjustable with a securing strap
- Dimensions (LxW): 320 x 150 mm

4032	4 Inch Roll	£9.95
4031	4 Inch D Roll	£9.95
4030	5 Inch D Roll	£9.95
4021	Winged Roll	£19.95



Posturite Seat Wedges

11° Wedge

The Posturite 11 degree wedge will allow you to sit down for long periods with the pelvis tilted correctly and the spine in its natural position. Dimensions (LxWxH): 380 x 355 x 90 mm.

Slimline Wedge

The Slimline wedge is perfect for use in a car where headroom is at a premium. It is also ideal for chairs which slant backwards and you feel the need for just a little more added support to ease muscle tension in the lumbar region. Dimensions (LxWxH): 370 x 355 x 50 mm.

Coccyx Wedge

Gently rotates the Pelvis forward to relieve the strain from the lower back. The coccyx relief recess guarantees maximum comfort for injured or bruised coccyx. Dimensions (LxWxH): 380 x 355 x 95 mm.

4033	11 Degree Wedge	£15.95
4034	Slimline Wedge	£15.95
4028	Coccyx Cut-Out Wedge	£34.95



Posturite Back Support

Designed to encourage a healthier position for the spine, the anatomically shaped Posturite Back Support gives lateral as well as lumbar positioning to ensure pain relief by correct alignment of the spine pelvis and legs.

- Ideal for the home where soft lounge chairs can provide very poor support
- Covered in washable plush velour with elasticated buckled strap
- Dimensions (LxWxH): 420 x 380 x 125 mm

4036	Posturite Back Support	£24.95
------	------------------------	--------



Posture Curve

Small, precisely shaped pad, designed to fit behind the small of the back and support the spine in its natural shape. Helps to relieve the symptoms of much back-pain and helps reduce the chances of getting back-pain in the future. Can be used in almost any type of seat.

- Includes securing strap
- Dimensions (LxW): 340 x 305 mm

4054	Posture Curve - Traditional	£26.95
------	-----------------------------	--------



Backfriend

Combined backrest and seat which can be used in any seat or chair - ideal for the car. Designed to give the correct support to both the lumbar and thoracic regions of the spine. Height adjustable to suit the individual.

- Backrest (LxW): 510 x 300 mm / Seatbase (LxW): 425 x 380 mm
- Also available with double padding

4010	Backfriend Black	£52.95
401002	Backfriend Double Padded Black	£55.95



3D Compression Belt

Suitable for lumbar - acral strain, sciatica, P.I.D and muscular injury

	Female		Male		
Small	56-71 cm	9889001	£68.89	9889101	£53.57
Medium	68-84 cm	9889002	£68.89	9889102	£53.57
Large	81-96 cm	9889003	£68.89	9889103	£53.57
XL	94-109 cm	9889004	£68.89	9889104	£53.57
XXL	107-122 cm	9889005	£68.89	9889105	£53.57



Abdominal Binder

High quality ventilated elastic with fully bound edges and soft padded front panel

- Suitable for post trauma, post surgical support and ventral hernia

9889201	Abdominal Binder Small	56-71 cm	£16.98
9889202	Abdominal Binder Medium	68-84 cm	£16.98
9889203	Abdominal Binder Large	81-96 cm	£16.98
9889204	Abdominal Binder XL	94-109 cm	£16.98



Maternity Belts

Single and 3 strap maternity belts

- Suitable for low back pain associated with pregnancy. The 3 strap version also offers additional abdominal support.

9889301	3 Strap Maternity Belt Small	56-71 cm	£21.23
9889302	3 Strap Maternity Belt Medium	68-84 cm	£21.23
9889303	3 Strap Maternity Belt Large	81-96 cm	£21.23
9889401	Single Strap Maternity Belt Universal	One size fits all	£16.98



Airprene Wrist Brace

High grade breathable Airprene material with stretch fabric on both sides with bound edges providing compressive support to wrist.

- Suitable for mild sprains and strains, mild symptoms of carpal tunnel syndrome, Rheumatoid, Osteoarthritis and healing fractures

	Left Hand		Right Hand		
Small	14-17 cm	9889511	£11.87	9889501	£11.87
Medium	16-18 cm	9889512	£11.87	9889502	£11.87
Large	18-20 cm	9889513	£11.87	9889503	£11.87
XL	19-21 cm	9889514	£11.87	9889504	£11.87



Airprene Wrist & Thumb Brace

High grade breathable Airprene material with stretch fabric on both sides with bound edges providing compressive support to wrist & thumb.

- Suitable for mild sprains and strains, mild symptoms of carpal tunnel syndrome, Rheumatoid, Osteoarthritis and healing fractures

	Left Hand		Right Hand		
Small	14-17 cm	9889611	£12.72	9889601	£12.72
Medium	16-18 cm	9889612	£12.72	9889602	£12.72
Large	18-20 cm	9889613	£12.72	9889603	£12.72
XL	19-21 cm	9889614	£12.72	9889604	£12.72



Disc 'O' Sit

For strength and stability exercises which can also develop balancing skills. Creates a stable yet moving platform for standing or seated exercise. The disc can be inflated to match the required level of stability, ideal for use on hard seating.

- Helpful in episodes of acute backpain
- To improve posture any time you have to sit

9300	Disco'o'sit	£24.95
------	-------------	--------

WorkRite

E-learning • Training • Consultancy

WorkRite, our health and safety compliance division, is the UK's premier independent provider of workplace health & safety, First Aid training, e-learning and management solutions.

Our products and services offer both flexibility and cost-effectiveness. So whether you are a small or medium sized business looking for total support from our fully-managed service, or a large national company requiring specialist back-up for your in-house team, we can tailor a package to suit your needs.

Our extensive range of desk-based e-learning and assessment programs, face-to-face training courses and consultancy services

will meet most companies' requirements. But there will always be occasions when something special is required. So if you can't immediately find the solution you are seeking, give us a call. We'll design something that will.

Whatever your requirements, you can expect the same high levels of customer care and service delivery on which Posturite has built its unrivalled reputation over the last 20 years.

WorkRite
e-learning & training solutions

E-learning

Desk-based e-learning is now the method of choice for most public and private sector businesses to deliver essential health and safety training to their office staff. It provides individual users with the flexibility to decide where and when they do their training and it gives you the data you need to decide what further actions, if any, need to be taken.

For a free online demo of WorkRite e-learning courses visit www.workrite.co.uk

AssessRite (DSE Training & Assessment)

An easy to use, learn and test course which offers a creative and commercially prudent route to help ensure that your organisation meets its health and safety obligations relating to DSE. Employees learn how to recognise the potential health risks involved in using DSE, how to sit correctly and how to avoid posture-related problems.

- Homeworkers version also available

HandleRite (Manual Handling Awareness)

The essential guide to correct manual handling. It is vital for employees' safety in the workplace to know and use correct manual handling techniques. HandleRite provides the essential guide to this. Frequent use of interactivity within the program ensures that the important points are reinforced and well understood.

FeelRite (Stress Awareness)

An introduction to the subject of control and stress. The course aim is to inform employees what stress is and what it is not; so encouraging them to look at their home and work lives to identify potential problems. Once they are aware of these it will help them to identify areas where improvements could be made to enable them to manage any issues.

CoshhRite (COSHH Awareness)

The course leads students through the requirements of the Control of Substances Hazardous to Health (COSHH) regulations which are designed to protect workers from hazardous substances. It teaches the importance of identifying substances, assessing their risk and devising and implementing protective measures.



Training

WorkRite's wide range of contemporary, multimedia training courses provide an interesting and stimulating learning environment where the emphasis is on participation and interaction. All our trainers are highly-qualified professionals experienced in a variety of training techniques and with extensive previous 'real world' experience in their respective fields.

We are proud to offer a wide range of modern multi-media first aid and health & safety courses, with an emphasis on practical skills, by some of the best highly qualified professionals in the UK. Courses include:

Ergonomics

- 1-Day Display Screen Equipment Assessor Course
- 1-Day Advanced DSE Assessor Course
- 2-Day Ergonomics Short Course (In association with Brighton University)

Fire and Evacuation

- 1/2-Day Fire Awareness Course
- 1/2 & 1-Day Fire Warden Training
- 1-Day Fire Warden Training
- 2.5-Hours Evacuation Chair Training
- 1-Day Evacuation Chair Train the Trainer*

Other Health & Safety

- 1-Day IOSH Working Safety
- 4-Day IOSH Managing Safety
- 1/2-Day Working at Heights Training
- 1/2-Day Risk Assessor Course
- 1-Day Conflict Resolution Training

Manual

- 1/2-Day Manual Handling Course
- 3-Day Manual Handling Train the Trainer*

First Aid

- 3-Day First Aid at Work
- 2-Day First Aid at Work requalification
- 1-Day Emergency First Aid at Work
- 1/2-Day First Aid at Work Refresher
- 2-Day Paediatric First Aid Course
- 1-Day Emergency First Aid for Children
- 3-Hour Oxygen Therapy Course
- 1-Day Combined Oxygen Therapy/AED Course
- 4-Hour Basic Life Support and AED Training
- 2-Hour Automated External Defibrillation (AED) training

*Delegates must have previous training experience

Office Health & Safety Awareness (OHSA)

An introduction to health and safety. This course will introduce the following areas where there is legislation to control risk and reduce work-related ill health. This includes: musculoskeletal disorders, working with computers, slips, trips & falls, electrical and fire safety, manual handling and welfare.

OHSA for Line Managers

Employers have a duty to protect employees and keep them informed about health and safety issues in the workplace. This course will help line managers to have a pro-active approach towards the health and safety of staff.

FireRite (Fire Awareness)

A simple but useful guide to fire safety and prevention, with instruction on the appropriate actions to take when faced with a possible fire hazard.

Trainees learn how to reduce or even eliminate fire risks, with interactive testing to ensure a high level of understanding.

MobileRite (Mobile Working)

A course which addresses the specific health and safety issues of mobile and remote workers. It includes information on DSE, driving, data security and personal safety.

Online management system

All WorkRite courses are supported by our unique online management system which captures essential information for your health and safety team and provides a fully-auditable trail of actions required or taken.

- Manage trainee data
- View all training records
- Follow an audit trail of actions required or taken
- Create and view reports
- Receive and set-up automatic reminders of training requirements and post-assessment actions
- E-mail trainees



Consultancy

WorkRite consultants can make sure that you implement and conduct an effective health and safety regime in accordance with current legislation.

You can concentrate on running your business while we ensure your procedures, policies, documentation, risk assessments, training programmes and so on are all kept up to date.

Our areas of expertise include:

- DSE (Display Screen Equipment)
- Fire Safety and Prevention
- Manual Handling
- Induction Packages
- Stress
- Risk Assessment
- Ergonomics
- Conflict Resolution

We can run a full range of training courses both in-house and at venues throughout the UK. In-house courses can be customised to suit as few or as many employees that you need to train. Many of our courses are accredited by the CIEH and all can be tailored to meet your specific needs.

For more information please contact us:

tel: 0845 345 0030
 email: support@workrite.co.uk
 web: www.workrite.co.uk

HELP!!!

WorkRite services include:

Posturite Consulting will work with you to complete your risk assessments to enable you to comply with legislation, write or adapt safety policies and procedures, offer training and generally assist you to comply with all health and safety legislation pertaining to your business.

Overload Service

Most Health and Safety Officers are now so busy they are prioritising and only getting part of their work done. If you could do with a hand to complete your risk assessments, training, or other health and safety tasks, give us a call. We'll be delighted to help.

Policies and Procedures

If you don't have either the time or the expertise to formulate health and safety policies, we can assist you. We have experience of working with many different industries so can write the policies and procedures appropriate to your business.

Risk Assessments

There is a mountain of legislation which now requires risk assessments to be carried out on a regular basis. Our experts will work with you to get them done.

Disaster Recovery Plans

Few businesses ever recover without a plan. Imagine what a flood or fire could do to your business. We can help you plan how you will cope if you lose your office through no fault of your own.

Ergonomic Audits

We've all heard of Repetitive Strain Injuries (RSI) or Upper Limb Disorders (ULD). Employers are often unaware of the bad practices that can exist in their own organisations. Our team of ergonomists and physiotherapists can carry out assessments to see if you have a problem and, if necessary, recommend remedial action.

Specific Ergonomic Assessments

Do you have an employee who's experiencing problems or a job you're concerned about? We're able to provide clear, expert advice to help resolve these types of issues.

Portable Appliance Testing

Every desk now has a display screen. There are printers, faxes and lots more besides. Who checks they are safe? We can.

Fire Safety

A radical change to workplace fire safety laws came into force on 1 October 2006. It requires all employers to carry out fire risk assessments on buildings for which they are responsible. Our experienced fire surveyors can carry out in-depth surveys of your premises to ensure compliance.

Office Environments

Office Re-Fit • Refurbishments • Design & Build

Office Environments

The way you design and fit out your offices says a lot about you as an employer and a business.

A well planned and equipped environment inspires staff, impresses clients and improves efficiency. An ill thought-out scheme does the complete reverse.

So it's important you get it right.

Office Environments has an enviable track record in helping companies to make the most of their space – and their budgets!

Whether designing and fitting out a single office, a suite of rooms or an entire building, we apply the same high levels of personal service and attention to detail that have helped to make Posturite the country's leading supplier of ergonomic office solutions.

Office space is too costly to waste. Let us work with you to meet your full office interior needs and objectives, within your budget and timescales.

Office Environments



Office Environments offers a full range of creative, cost-effective interior solutions along with a space planning / design facility. With our business associates we can offer full interior solutions together with full project management.

From empty shell or existing office to completed project, from space planning through furniture selection and installation, we provide an efficient, creative turnkey service.

Our areas of expertise include:

- Full Project Management
- Interior Design
- Space Planning
- Partitioning
- Lighting
- Floor Coverings
- Mechanical & Electrical Works

Ask us about Leasing options

Spread the cost of projects over 3-5 years, preserve capital expenditure & save tax!

Whether your project is...

large or small, you have nothing to lose by contacting us to see for yourself.

.....

tel: 0845 4080 640
 email: support@office-environments.co.uk
 web: www.office-environments.co.uk

We are here every step of the way...

Office Environments provides a dedicated Project Manager to manage the process from start to finish. We aim to create an effective space that meets your requirements and exceeds your expectations.

We're with you every step of the way:

- Assessment / research
- Detailed quotation and proposal
- Schedule of works
- Weekly update of project progress
- Financial options available



Case Study



Value of Job: £31,500

Client's Expectations: New boardroom with table to be inclusive of seating & audio visual equipment. Image & style to represent a modern theme in line with the client's own modernistic product design

Works Carried out: Designed, manufactured & supplied the boardroom table and supplied the executive seating

Products: Bespoke boardroom table, HAG seating



Case Study



Kingslegal

- Value of Job:** £380,000
- Client's Expectations:** To fit out 28,000 sq feet of new offices, reception area, training room, boardroom and restaurant
- Works Carried out:** Seating, desking, storage, reception, training room, canteen, kitchen, breakout areas & meeting rooms
- Products:** Herman Miller AE desking, seating, steel storage, folding tables & breakout furniture. CBS monitor arms. Anco storage wall system & Lamb Macintosh bespoke reception unit



MediRite

First Aid Supplies • Defibrillators • Evacuation Chairs



We're all looking for savings at the moment. But the most important saving you will ever make is someone's life.

That's why, even in these tough economic times, there are some things you simply cannot afford to be without or ignore.

Evacuation Chairs: More than 30,000 workplace fires take place every year. You could be liable if all methods of escape haven't been provided.

Defibrillators: Two hundred and fifty people a day die from sudden cardiac arrest (SCA). Even if you think it unlikely that anyone will have a SCA on your premises, why take the risk?

First Aid Training: Are all your appointed First Aiders' certificates up to date? Please see the following pages for more information.

First Aid Supplies: Are your premises fully stocked with the dressings and equipment needed to deal with cuts, scalds and other minor injuries in accordance with HSE requirements?

We have all the products and training services you need to meet your essential Occupational Health and First Aid obligations.

What you see here is only a small sample of what we offer. You will find the full range on our newly revamped website at www.medirite.co.uk where you can also open an online account that not only makes ordering more convenient, but also gives you access to a range of discounts and special offers.

We treat all our customers as individuals and tailor our services to meet your specific needs. So whether you require our gold standard, all-encompassing, fully-managed service or a simple statutory First Aid kit, our customer service team will be delighted to hear from you.

www.medirite.co.uk



MediRite Plus HSE First Aid Kit

HSE First Aid Kit. Durable polypropylene box with black safety clips, integrated carry handle, and secure airtight lid provides protection from dust and water. All contents meet Health & Safety Executive guidelines.

- For full list of contents, please visit www.medirite.co.uk

MF112	MediRite Plus HSE 10 Person Kit	£19.99
MF113	MediRite Plus HSE 20 Person Kit	£24.99
MF114	MediRite Plus HSE 50 Person Kit	£39.99



MasterChef All Blue Catering Kit

The first and only completely blue HSE catering first aid kit. Plasters, bandages, dressings, gloves, wipes - everything is blue. All contents meet Health & Safety Executive guidelines.

- For full list of contents, please visit www.medirite.co.uk

MF178	MasterChef 10 Pers All Blue Catering Kit	£19.99
MF186	MasterChef 20 Pers All Blue Catering Kit	£24.99
MF191	MasterChef 50 Pers All Blue Catering Kit	£39.99



First Aid Refill Kits

Complete refill kits for HSE and Catering First Aid Kits.

- For full list of contents, please visit www.medirite.co.uk

MF121	Refill MediRite HSE 10 Person	£15.99
MF122	Refill MediRite HSE 20 Person	£19.99
MF123	Refill MediRite HSE 50 Person	£25.99
MF387	Refill Masterchef HSE 10 Pers All Blue	£15.99
MF388	Refill Masterchef HSE 20 Pers All Blue	£19.99
MF389	Refill Masterchef HSE 50 Pers All Blue	£25.99



MediRite Plus Burns Kit

Emergency burns kit meeting the guidelines given by the Health & Safety Executive. Highly visible red box in durable polypropylene, orange safety clips and integrated handle. The kit provides fast and effective treatment for burns, scalds and sunburn in the workplace or home.

- For full list of contents, please visit www.medirite.co.uk

MF124	MediRite Plus Burns Kit	£27.99
-------	-------------------------	--------



MediRite Plus 3 Station Eyewash Kit

The 3 Station Eyewash Kit is in a stylish clear box in durable polypropylene, black safety clips and integrated handle, can be wall mounted. Providing fast and effective treatment for minor eye injuries in the workplace or home, meeting the guidelines given by the Health & Safety Executive.

- Contents: 3 x sterile eyewash 500 ml, 3 x eye pad dressing, wall bracket

ME907	MediRite Plus 3 Station Eye Wash Kit	£27.99
-------	--------------------------------------	--------



Compact First Aid Kits

Travel First Aid Kit

The ideal first aid kit for business or holiday travel, both abroad or at home.

Vehicle Compact First Aid Kit

A quality first aid kit for the car. Ideal for motoring in Europe where in some countries a first aid kit is a legal requirement.

MF151	Travel First Aid Kit Bag Full	£12.43
MF155	Compact Vehicle First Aid Kit Bag Full	£14.20



Alcohol Hand Gel

Alcohol (70%) hand rubs are an established alternative to soap and water when hand washing is impractical or impossible. Hospital grade with skin protection properties. Three 50ml bottle types available.

- 3 x 50 ml bottle types available

MKH8764	Alcohol Hand Rub 50ml Bottle Flip Top	£1.10
MKH8763	Alcohol Hand Rub 50ml Spray No Clip.	£1.20
MKH8761	Alcohol Hand Rub 50ml Spray + Clip	£1.50



Assorted Plasters

Four types available: Washproof, Blue Food Area, Fabric and Multisoft.

MP516	Fabric Plasters Assorted Pack 100	£6.43
MP517	Fabric Plasters Assorted Pack 20	£1.21
MP526	Multisoft Plasters Assorted Pack 100	£4.48
MP527	Multisoft Plasters Assorted Pack 20	£0.91
MP536	Washproof Plasters Assorted Pack 100	£4.04
MP537	Washproof Plasters Assorted Pack 20	£0.83
MP546	Blue Food Plasters Assorted Pack 100	£5.83
MP547	Blue Food Plasters Assorted Pack 20	£1.14



Biohazard Combination Clean Up Kit

This kit contains 3 single application body fluid clean-up packs, and 2 single application sharps clean-up packs. Meets the current Health and Safety requirements.

- Visit www.medirite.co.uk for more Biohazard kits

MX983	Biohazard Combi Clean Up Kit	£56.99
-------	------------------------------	--------



LIFEPAK CR Plus Defibrillator

Featuring the same advanced technology trusted by emergency medical professionals - yet simple to use - the LIFEPAK CR Plus automated external defibrillator (AED) is designed specifically for the first person to respond to a victim of sudden cardiac arrest (SCA). Although not everyone can be saved from sudden cardiac arrest, studies show that early defibrillation can dramatically improve survival rates. AED training courses available on request through our WorkRite division.

Confidence is knowing you will be ready

- Weekly & monthly self tests plus four visible readiness displays let you know if the CR Plus is ready to do its job.
- Simple maintenance with synchronized replacement for CHARGEPAK™ battery charger & QUIK-PAK™ electrodes.

Confidence is a simple two-step process

- Smart, safe device designed to shock only if needed
- Designed specifically for minimally-trained users
- Fully automatic model with 2-step operation:
 1. Turn on device.
 2. Apply electrode pads.
- Leasing options available please contact head office
- Full range of alarmed wall cabinets available

MV400	LIFEPAK CR Plus AED Automatic Inc Soft Case & Rescue Pack	£1,495.00
MV402	LIFEPAK Electrodes Kit No 2 (Exp 2 yrs) 2 x Set of Electrodes + 1 x Battery Charger Pack	£79.00
MV403	LIFEPAK First Responder Rescue Pack 2 x Gloves, 1 x Mask with Valve/Filter, 1 x Razor, 1 x Scissors	£20.00
MV410	LIFEPAK CR Plus Training Unit Inc 1 x Set of Training Electrodes	£315.00
MV411	LIFEPAK Training Electrodes Pack 5 sets	£29.00
MV415	LIFEPAK Electrodes Set of 1 (NO Battery)	£19.00
MV404	LIFEPAK CR Plus AED Wall Bracket	£40.00

EvacuRite®

Evacuation Chair

EvacuRite is a best-in-class, economically-priced evacuation chair that excels in terms of ease and speed of use, comfort, manoeuvrability and durability. It is suitable for use in almost any environment and emergency situation where a person may be required to be smoothly and safely transported down stairs.

- Simple rapid-deploy system - allows the chair to be ready for use in seconds with no heavy lifting
- Lightweight aluminium frame - making it the lightest evacuation chair in its class
- Can be used as an alternative transit / wheelchair
- Smooth, safe, glide-track system ensures a comfortable and controlled evacuation down stairs
- Dual rear brakes at waist level for easy application
- Forward-extending, ergonomically-shaped handles assist manoeuvrability
- Adjustable chest, lap and shin straps
- Adjustable head/neck support
- Wipe-clean material
- Wall attachment bracket - no lifting required
- Cover included
- Full instruction manual including trained operator / maintenance inspection log
- 5 year guarantee
- Directive 93/42EEC Medical Devices - Class 1
- EvacuRite training courses available on request

DIMENSIONS

Weight of chair	15.9 kg
Maximum load	160 kg
Height closed	113 cm
Height open	160 cm
Seat width	46 cm
Seat depth	44 cm
Seat back height	49 cm
Seat height from floor	49 cm

Evacuation Chairs

Are you equipped to evacuate your site in the event of an emergency?

The Regulatory Reform (Fire Safety) Order 2005 says that you must manage any fire risk in your premises. You must take reasonable steps to ensure that everyone on the premises, or nearby, can safely escape if there is an emergency.

- We can offer Evacuation chair product training with our whole range of chairs. Please call for more information.



Folded ready for storage



Transit mode



Stored neatly away

MKV101 EvacuRite Evacuation Chair £795.00



Assistive Technology

Training • Hardware • Software

iansyst Ltd is a UK market leader in assistive technology solutions for people with disabilities such as visual impairment and dyslexia. Its world-leading portfolio of products and services, and its dedicated team of professional advisers, are available to Posturite customers through a collaborative venture that also allows iansyst's customers to access our unrivalled expertise in workplace

health and safety, ergonomics, assessments and e-learning. It offers the customers of both companies a single source route to an extended range of solutions and services.

Assistive Technology

In partnership with: 

Assistive Technology Training

Iansyst's team of specialist trainers and consultants are able to offer a comprehensive service solution including screening for dyslexia, diagnostic assessments for specific learning difficulties (dyslexia, dyspraxia & dyscalculia) and workplace assessments for a range of disabilities. Their top quality training team are able to provide specialist Assistive Technology training at both a strategic and hands on level and specialise in integrating Assistive Technology software with clients' existing packages. They will listen to your requirements and develop an interesting and informative programme and provide training materials for future reference.

What is Assistive Technology (AT) Training?

Training for the individual will make sure you get the most out of the software and other technology that has been purchased.

One-to-One Assistive Technology Training

Set in a familiar and stable environment, one-to-one training allows you to be trained on your own computer at your pace. The training sessions are structured, but flexible enough to give you as much hands-on experience as possible, with your needs being discussed beforehand to make sure your requirements are met.

9821022	Iansyst Software Training Session 3 Hrs	£249.00
9821124	1 to 1 Workplace Strategies Session	£395.00
9821063	Dyslexia Diagnostic Assessment	£525.00



Dragon NaturallySpeaking v11

Most people speak over 120 words per minute but type less than 40 words per minute. What if you could create email, documents and spreadsheets simply by speaking?

With speech recognition software from Nuance Communications, you can turn your voice into text three times faster than most people type. Just start talking, and the software will recognize your voice instantly, with up to 99% accuracy. It takes only minutes of training to get started, and accuracy will continually improve the more you use the software.

- Noise-cancelling headset microphone (included)
- Premium version - for small businesses and individuals
- Professional version - for larger businesses and more features
- Please visit our website for full features & specification

9821125	Dragon v11 Professional Wired	£499.00
9821126	Dragon v11 Professional Wireless	£549.00
9821127	Dragon v11 Premium Wired	£127.65
9821128	Dragon v11 Premium Wireless	£170.20



Digital voice recorders

Olympus WS750M digital voice recorder

With outstanding Olympus recording and playback quality this delightful WS750M can fit easily into any pocket, perfect for recording short memos.

Olympus DM-5 digital voice recorder

The Olympus DM-5 is a sophisticated digital voice recorder which provides high-quality audio processing at your fingertips.

- Please visit our website for full features & specification

9821173	Olympus DM-5 Digital Voice Recorder	£212.76
9821175	Olympus WS750M Digital Voice Recorder	£66.00



Livescribe 8GB Echo Corporate Bundle

Livescribe Echo Smartpen records everything you hear, write and draw. This stylish modern piece of technology is a very useful product that captures your handwriting on special paper and allows you to link very good quality audio that the pen records to the text you have written.

- Please visit our website for full features & specification

Kit includes: Livescribe 8GB Echo Smartpen, Livescribe Echo 3D Recording Earbuds, MyScript for Livescribe 1.0 for PC, Livescribe ink, 4x Black - 1x Red, Livescribe Lined Black Journal (1-2) 2Pk, Livescribe A4 100 sheet pad.

9821174	Livescribe 8GB Echo Corporate Bundle	£235.00
---------	--------------------------------------	---------



Franklin DMQ-1870 Speaking Dictionary

Portable dictionary/thesaurus with phonetic spell checker and speech. Built-in speech function lets you hear the spelling suggestion, headwords and definitions making it easier to find the right word.

- Contains over 6,000 references from the Collins Cobuild Idioms Dictionary
- 180,000 word phonetic spell corrector - from 'fizix' to 'physics'
- Please visit our website for full features & specification

9821005	Franklin DMQ-1870 Speaking Dictionary	£85.00
---------	---------------------------------------	--------



ClaroRead Plus v5.5

Simple and easily adaptable Text-to-Speech tool to support reading and writing. ClaroRead text to speech software is closely integrated with Microsoft word providing enhanced proof reading tools.

- High-quality voices including a new Scottish voice
- Supports 25 different languages
- Powerful integration with Dragon NaturallySpeaking
- Please visit our website for full features & specification

9821053	ClaroRead Plus v5.5 Single	£159.00
---------	----------------------------	---------

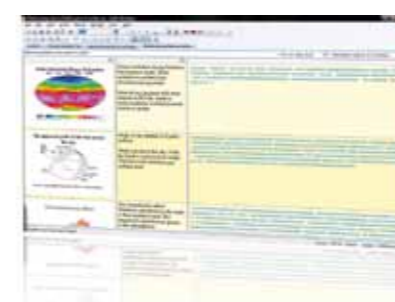

Audio Notetaker v2.3

This innovative piece of software enables you to make better notes through audio recording. Get help with navigating, annotating and organising your notes and audio files, then export your recording and notes to Microsoft Word or a portable audio device.

- Live Notetaking
- Audio and notes file manager
- Please visit our website for full features & specification

9821058	Audio Note Taker v2.3 Single	£79.95
---------	------------------------------	--------

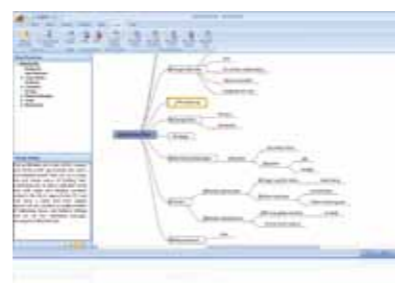

MindGenius Business

MindGenius is a flexible concept and mind mapping program with advanced exporting and formatting functions. An ideal tool for both mind mapping or planning reports, projects, presentations or even web pages.

- Use colour to group and classify ideas
- Multiple map layouts make best use of white space
- Export to MS Word, PowerPoint, Project, PDF and Visio
- Please visit our website for full features & specification

9821011	MindGenius Business Single Licence	£147.00
---------	------------------------------------	---------



Read&Write Gold v10

This innovative toolbar overcomes the problems associated with accessing and composing written material by providing speech feedback, phonetic spellchecking and many other support tools.

- High quality speech feedback for reading aloud with text highlighting
- Dictionary and thesaurus with simple and advanced definitions
- Reads aloud words and phrases recognised by Dragon NaturallySpeaking
- Please visit our website for full features & specification

9821172	Read & Write V10 Gold Single	£320.00
---------	------------------------------	---------



ZoomText level 1 and level 2

ZoomText Level 1 enlarges and enhances everything on your computer screen, making all of your applications easy to see and use. ZoomText level 2 comes with all the functionality of level 1, with the addition of speech feedback.

- Flexible magnification to 36x
- Please visit our website for full features & specification

9821088	ZoomText L2 v9.1 Single Licence	£495.00
9821089	ZoomText L1 v9.1 Single Licence	£375.00

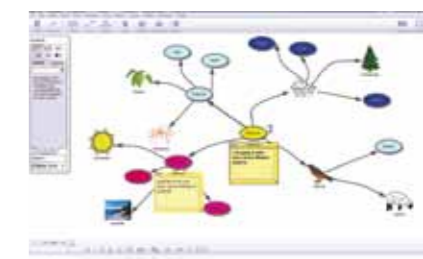

Inspiration v9

Mind mapping software provides end users with an essential framework for thinking. Inspiration can be used for visual mapping, outlining, writing and making presentations by providing a platform to organise your ideas.

- Visual learning support for reading, writing and thinking in Diagram View
- Map View-A new visual view to create and think with mind maps
- Drag-and-drop images and files on to your ideas
- Please visit our website for full features & specification

9821012	Inspiration v9 Single Licence	£59.00
---------	-------------------------------	--------

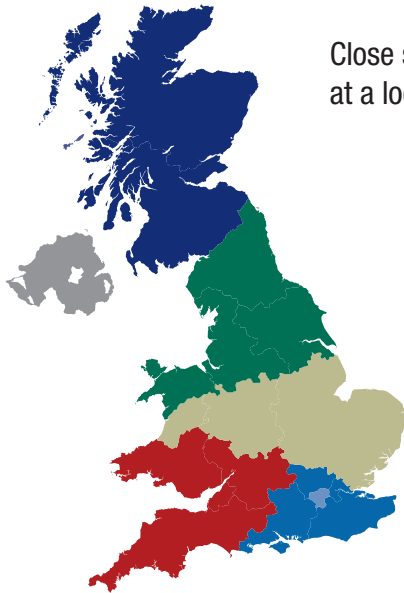

Close support
at a local level.

North

Matt Tickle

Regional Manager
+44 (0) 7966 973109
mattickle@posturite.co.uk

Andy Rigby

Key Account Manager
+44 (0) 7970 631803
andyrigby@posturite.co.uk

Katie Wilkinson

North Central
+44 (0) 7825 981503
katiwilkinson@posturite.co.uk

South West

David Kirtley

Regional Manager
+44 (0) 7753 815817
davidkirtley@posturite.co.uk

Tom Wood

Key Account Manager
+44 (0) 7971 221474
tomwood@posturite.co.uk

Leon Jeffrey

North West & South Yorkshire
+44 (0) 7920 494926
leonjeffrey@posturite.co.uk

Eugene Larkin

North East
+44 (0) 7753 815818
eugenelarkin@posturite.co.uk

David Gleeson

South West & South Wales
+44 (0) 7827 241854
davidgleeson@posturite.co.uk



Printed in the UK using environmentally considerate and sustainable printing technology. As much dry waste as possible, including printing plates, ink tins and paper waste produced during production are recycled. The paper for this publication is FSC certified being sourced from sustainably managed forests and is printed by a company certificated to Environmental Management System, ISO 14001.

During its production every effort has been made to minimize the Carbon footprint and reduce the environmental impact of this publication.

Sales Managers

Geoff Thompson

UK Sales Director
+44 (0) 7967 046673
geoffthompson@posturite.co.uk

Jamie Hall

Sales Manager, London & South East
+44 (0) 7977 267682
jamiehall@posturite.co.uk

Scotland

Scott Andrews

Scotland
m. +44 (0) 7825 534352
e. scottandrews@posturite.co.uk

Blair Paton

Scotland
+44 (0) 7812 053025
blairpaton@posturite.co.uk

Scott Bottomer

Scotland
+44 (0) 7584 488899
scottbottomer@posturite.co.uk

Midlands

Mark Walker

Regional Manager
+44 (0) 7980 240311
markwalker@posturite.co.uk

Chris McGrath

West Midlands
+44 (0) 7500 085742
chrismcgrath@posturite.co.uk

Laura Luckman

East Midlands
+44 (0) 7815 730237
lauraluckman@posturite.co.uk

London & South East

Chris Hollely

Regional Manager
+44 (0) 7971 221459
chrishollely@posturite.co.uk

Matthew O'Sullivan

City & East London
+44 (0) 7973 840864
mathewosullivan@posturite.co.uk

Jonathan White

City & East London
+44 (0) 7827 352311
jonathanwhite@posturite.co.uk

Paul Lindsay

West & South West London
+44 (0) 7813 695691
paullindsay@posturite.co.uk

Pete Barret

West & South West London
+44 (0) 7500 086439
petebarrett@posturite.co.uk

Matt Jones

South East
+44 (0) 7966 018119
mattjones@posturite.co.uk

James Moxon

South East
+44 (0) 7825 890626
jamesmoxon@posturite.co.uk

Sue Greenham

South East
+44 (0) 7970 870967
suegreenham@posturite.co.uk

Antony Burns

North and West London
+44 (0) 7812 053042
antonyburns@posturite.co.uk

Posturite Ltd. The Mill, Berwick, East Sussex, BN26 6SZ

t: +44 (0) 845 345 0010 | f: +44 (0) 845 345 0020 | e: support@posturite.co.uk

www.posturite.co.uk

Registered in England No. 2574809

